

Striving to make products that move you.

**ORION**

# Chiller Catalogue

## Taking Temperature Control Technology to the Limit!

**NEW** ORION's DC Inverter Chiller now joins our  
lineup of CE Marking Certified equipment!



DC Inverter Chiller  
RKE2200B1-V-G2



Digi-Eco Chiller  
RKED2200A-V



Inverter Chiller  
RKE11000A-V

Coolant Chiller  
RCC1500B1



Eco Hybrid  
FCC10A



## A New Concept in Temperature Control

Ultra ECO Product: Energy savings of over 50% (compared with earlier models)  
"ECO2" means Economy (energy savings) and Ecology (environmental protection) and reduced CO2 emissions.



Specially made for outside installation.

# Eco Hybrid (Built to order product)

## Making the Most of Natural Energy Maximized Energy Savings

### What Is Eco Hybrid?

First in the World!※ The NEW Digi-Eco Chiller -- an energy saving chiller with built-in digital compressor, plus ORION's combined fan cooled and water mist cooled cooling unit for energy AND space savings! The Eco Hybrid is ORION's chilling system offering that keeps you one step ahead of the rest!

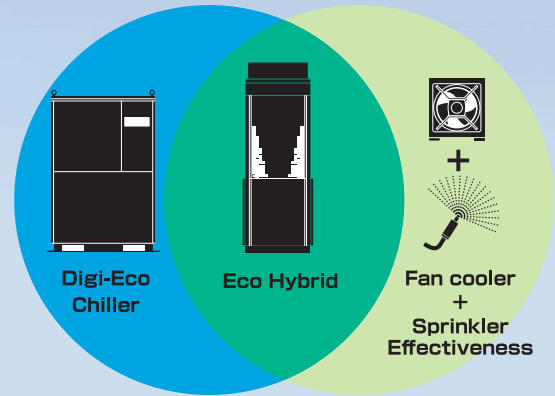

※ Refer to P.5

### Takes advantage of the climates of all seasons, savings in power consumption as high as 65% can be achieved.

Operated in Japanese seasonal weather through winter and cooler seasons, cooling will be primarily handled by the fan cooler for outstanding savings in overall yearly electrical costs.

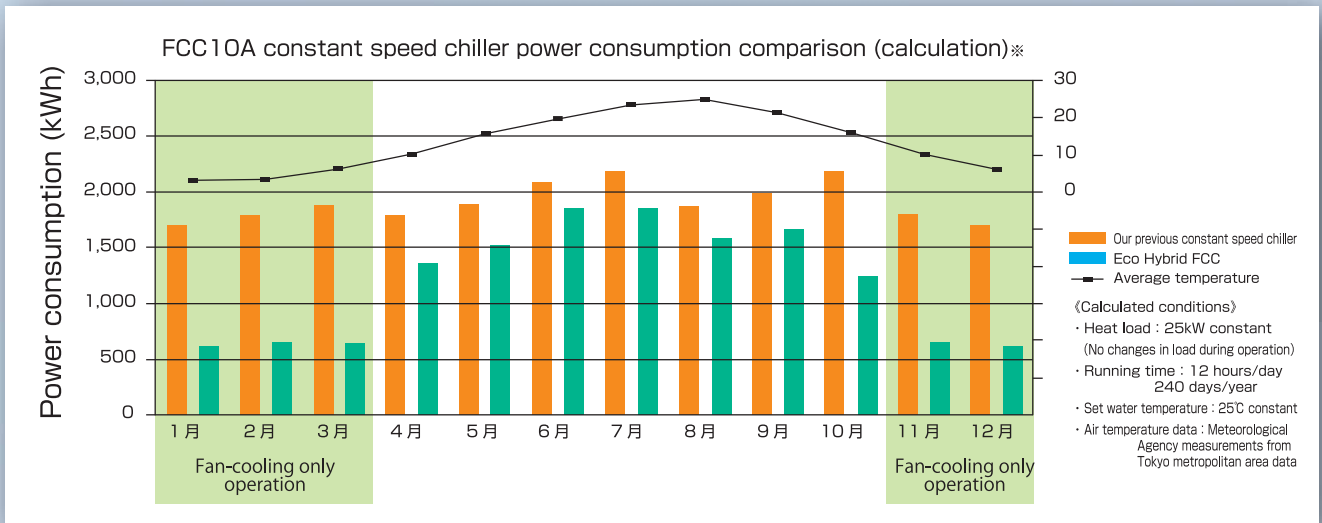

### Annual power consumption compared with previous models:

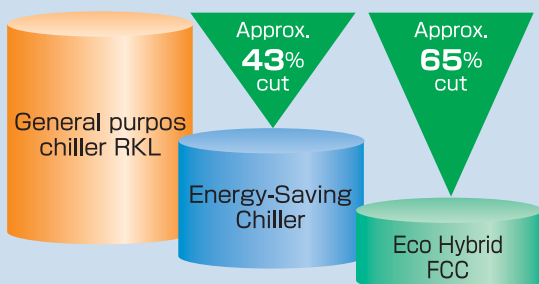

Yearly electric bill reduction: approx.  
**¥300,000**※

※Exact power and cost savings will depend on the particular weather/climate and water temperatures at the place of installation as well as unit load conditions.

### Heat Exchanger Corrosion Countermeasures

Cathodic electrodeposition coating that protects the heat exchanger against water spray.\*2



### Water spray is very effective in intense heat.

Wide operable ambient temperature range increase to **-10 to 45°C** \*1

Works well in harsh environments.

Fluid temperature setting range:

**18°C - 35°C.**

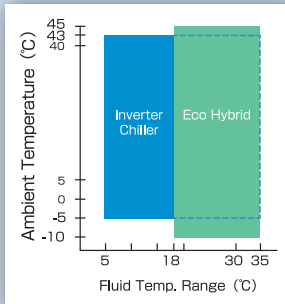

FCC10

\*1 For ambient temperatures below 5°C, measures must be taken to ensure that piping outside the chiller does not freeze.  
 \*2 Please clean off scaling from water spray periodically.

### Automatic selection of most efficient mode.

3 built-in operating modes  
 The optimum mode is automatically chosen.

Operating Mode	Eco Hybrid operating conditions
Mode 1	Compressor (normal air-cooled chiller) + Water spray
Mode 2	Compressor + Fan cooler (combined operation) + Water spray
Mode 3	Fan cooler + Water spray

Season	Spring	Summer	Autumn	Winter
Fan cooler	Active	Active	Active	Active
Water spray	Active	Active	Active	Active
Compressor	Active	Active	Active	Inactive
Operating Mode	Mode 3	Mode 2	Mode 1	Mode 3

### Surprising Space Savings

Takes up approx. 50% less space than our previous models.

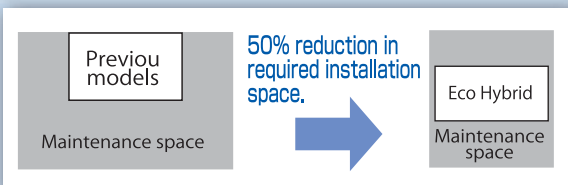

### As many as 5 units can be connected.

As many as 5 units can be installed right next to each other. The number of active units is controlled based on the current load.

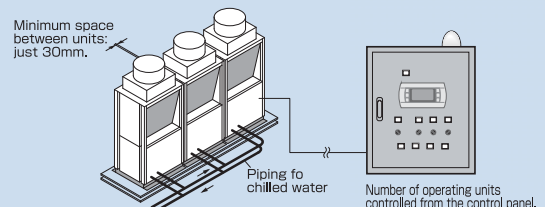

# DC Inverter Chiller Series

## Minimum 30%\* Energy Savings AND Precision Temperature

## Fully Loaded with Superior Functionality to Meet All the Your Application and Working Environment.

### Energy saving

**As much as 65% Energy Savings Possible**

Even compared with power saving ON/OFF type chillers, our DC Inverter control models offer energy savings of 30% at full load. And when compared with temperature-stable hot gas bypass or PID proportional valve controlled chillers, a 65% reduction in energy requirements is possible.

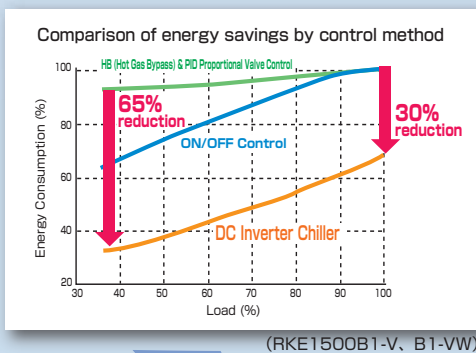

### High Accuracy Temperature Control

**Temperature control accuracy to  $\pm 0.1^\circ\text{C}$  . \***

Precise control even for applications that have severe temperature management requirements. Its extreme versatility makes it suitable for a wide range of applications, including precision-production-use lasers, analysis devices, semiconductor manufacturing, and many others. \* Under stable load and ambient temperature.

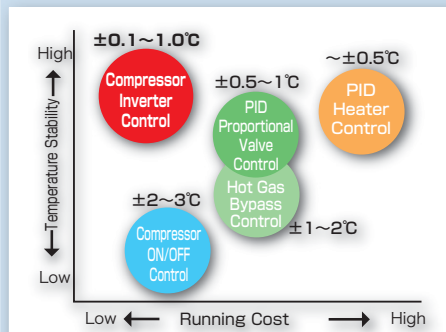

Our inverter controlled compressor responds to fluctuating workloads linearly, achieving highly accurate temperature control while using the least amount of energy. Plus, thanks to Orion's distinctive capacity control system, accurate temperature control can still be maintained during normally difficult to control low load situations.

(User can choose between "High-accuracy" and "Energysaving" modes in response to low-load conditions.)

## No Trade-Off between Low Energy and High Accuracy Control -- Now Orion Offers Both!

### Wide Range of Operating Conditions

Fluid temperature control range of  $5 \sim 35^\circ\text{C}$  makes this chiller suitable for a widerangeofpotential applications. Also, thanks to improved functionality, includingcondensation-prevention, operation in high-temperature environments is also possible.

Works in a wide range of ambient temperatures from  $-5$  to  $+43^\circ\text{C}$  . \*

This means our chiller can do its job under even harsher working conditions.

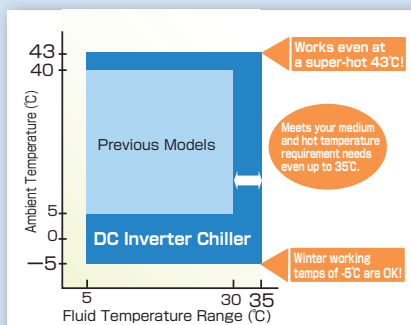

High Efficiency Refrigerant R410A

Our chillers now use R410A refrigerant, which improves cooling efficiency by about 1.4 times compared with R407C.



DC Compressor Motor - Inverter Controlled

In order to achieve even further energy savings, our compressor is built with a highly efficient brushless DC motor.

With Orion's specially developed inverter driver, as well as our newly developed controller, we have achieved a highly optimized refrigeration cycle.



\* For ambient temperatures below  $5^\circ\text{C}$  , measures must be taken to ensure that piping outside the chiller does not freeze.

# Control of $\pm 0.1^{\circ}\text{C}$ !

※ Compared with our earlier models.

## Requirements of



### Compact and Quiet

#### Unit volume cut by 40%.

Compared with RKE2200B1-V(W) and RKED2200A-V(W) models.

#### Operating noise level cut by 3 dB.

From 67 dB to 64 dB.

Compared with RKE2200B1-V(W) and RKED2200A-V,60Hz models.

#### CE Marking certification available to order

(RKE750A1-V, RKE1500B1-V, B1-VW)



Comparison of RKED2200A-V and RKE2200B1-V



- Can be easily configured for top or side ventilation. (Adaptable to a wider variety of workspaces.)

Except for RKE2200B1-V(W)

Patent pending

### Built for Improved Ease of Use



- Slanted front panel design is easy to see AND easy to operate.



- Tank access is at the top for easy access, easy water quality confirmation, easy cleaning!



- Easy "One Touch" removable condenser dust filter.

#### External Communications Capability

Operation and control functions, as well as fluid condition monitoring all from your PC via a single cable hookup.

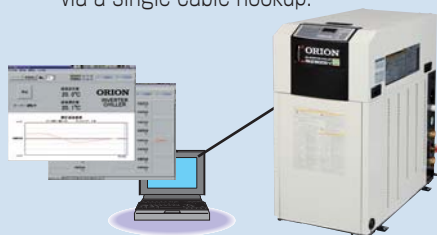

#### Multi-Function Parameters

Using the Multi-Function Parameters, users can tailor the chiller operation to best suit their many needs and operating conditions.

Function	Description
Blackout, power-outoff recovery setting	"No recovery", "Auto recovery", "Remote switch priority", and "Either Local or Remote Switch On" options available.
Local/Remote operation	User can choose between "Local only", "Remote only", "Both local and remote" operation modes.
Alarm signal out	Option for alarm signal contacts to "Open" or "Close" during alarm.
Alarm State Operation Control	Options to "Continue" or "Halt" operation of still-working components under warning conditions.
Audible alarm	Audible alarm "Enabled" or "Disabled" during alarm condition.
Audible warning	Audible alarm "Enabled" or "Disabled" during warning condition.
Freeze prevention operation	To prevent freezing, Auto pump operation "Enabled" and "Disabled" options available.
Warming up operation	Option to keep pump running even when chiller is off, in order to maintain a (set) minimum fluid temperature.
Energy saving mode	Option to shut off compressor when cooling load falls below 40% for increased energy savings.
Low-noise mode	Optional reduced noise output by lowering the maximum fan speed to 40Hz or below. (Cooling power reduced about 20%.)
500hr fi lter replacement warning	500 hr fi lter replacement warning "Enabled", "Disabled" options available.
Fluid temp high/low warning	5 fi uid temperature limit setting patterns available.

### Equipped with a Wealth of Options.

Users have many options to choose from such as Remote control, Heaters, Communication software, and others to further suit their application requirements and operating environment.

# The first among the world※!

※ Among industrial use chillers.

## Built-in Digitally Controlled Compressor



Patented

**Digital Control Energy Saving Chiller Series (RKED-A).**  
Our chillers meet your increasing needs by providing energy savings and highly accurate temperature control even under low loads.

## Both Energy Savings AND Precision Control, even under low loads.

Our chillers offer efficient and energy saving operation in all loads from 0 to 100% thanks to Orion's original Digital Control and Load/Unload technology. Because of this breakthrough, Orion has achieved what was previously impossible for inverter controlled chillers -- energy savings and precision control at loads as low as 30% and below.

Comparison of Energy Savings by Control Method

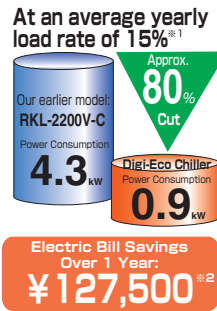
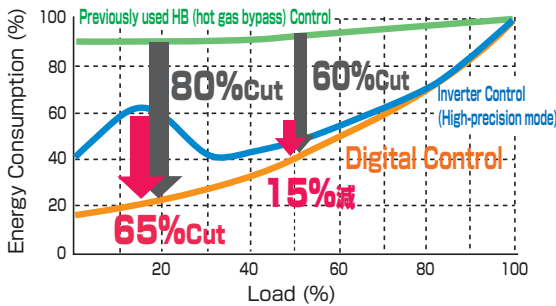

※1 Rated conditions: (Ambient temperature: 32°C, Fluid temperature setting: 20.)

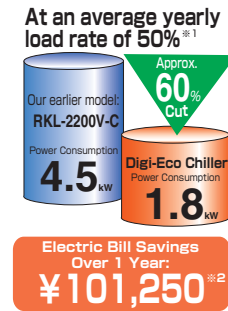

※2 Calculations based on a running time of 10 hours/day, 250 days/year, at an electricity rate of ¥15/kWh.

## Safe and Reliable Design

Our chillers are reliable thanks to the simplicity of the components used. And yet we also offer advanced features such as computer based control and monitoring. We have a tried and true design that has inherited the best functionality of inverter chillers, and the result is a chiller that performs reliably and meets all of your needs.

## Patented What is Digital Control?

Digitally Controlled Compressor

The compressor built into the chiller has a clutch mechanism which enables it to be repeatedly engaged and disengaged. By changing the rate of this engage/disengage cycle, the temperature of the fluid to be cooled can be accurately controlled. Much like the clutch works in an automobile, when the load is small, the clutch is disengaged for longer periods, thus allowing for the highest energy savings possible.

Digitally Controlled Operation

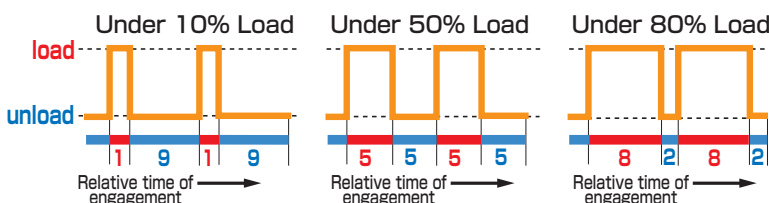

RKED2200A-V

# Special Features of our Chiller and Unit Cooler Series

**ORION**

Orion Chillers Industrial Chillers with a Solid Record of Superior Reliability.

## 1. Built in dedicated digital temperature control system.

**Digital Temperature Control**
**External Signal Terminals**

- Orion's distinctive temperature control system makes our chillers easy to operate. We've eliminated the need for complicated control settings.
- The built-in digital display shows temperature settings, the measured temperature, and error codes. Water temperature control is easy, and if by some chance trouble does occur, the cause can be easily identified by a quick check of the displayed error codes.
- Equipped with External Signal Terminals  
By hooking up to the Operating Signal, Warning Signal, and Remote Control terminals, you can remotely operate and monitoring the operating conditions of our Unit Coolers.

※ The number and type of functions differ according to the model. Please refer to the specifications of individual models for further details.

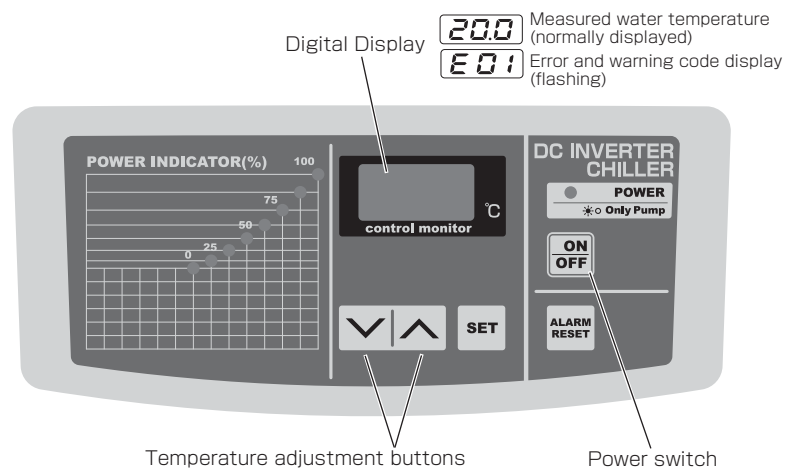

## 2. With a broad product line-up and built-to-order options available, we can meet all of your chiller needs.

- Orion offers 36 chiller models in all, including those without water tanks (for open loop systems), with built-in water tanks (for closed loop systems), air cooled, and water cooled types.
- Our models with built-in water tanks have the necessary tank and pump already built into the unit, eliminating troublesome on-site piping installation typically necessary for closed loop systems.
- Orion also offers custom, built-to-order models in order to fully meet the needs of our customers who have special application requirements.

Type	Air Cooled	Water Cooled	Total
Without Water Tank (Open loop system)	10	1	11
Built-in Water Tank (Closed loop system)	15	11	26
Total Number of Models Available	25	12	37

## 3. Operation Under a Wide Range of Conditions

Wide fluid temperature control range of 5 ~ 30°C (ambient temperature: -5 to 43°C . ※ ) (The temperature control range on our DC Inverter chillers, Digi-Eco chillers, and Inverter chillers is 5 ~ 35°C , and the control range on our Energy Saving Hybrid chillers is 10 ~ 30°C .)

Compared to the 5 ~ 15°C temperature control range on typical chillers, Orion's chillers offer a much wider range of use.

※ The RKS Series models without built-in water tanks have a fluid temperature control range of 5 ~ 25°C (under ambient temperatures of 5 ~ 40°C .)  
Our Super Heavy Duty models have a fluid temperature control range of 15 ~ 30°C .

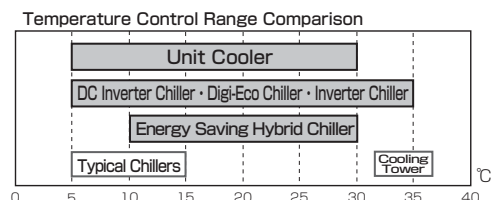

# Chiller and Unit Cooler Cooling Output

Orion Chillers : Industrial Chillers with a Solid Record of Superior Reliability.

## Chiller Cooling Output Chart

**P.11** See this page for model details.

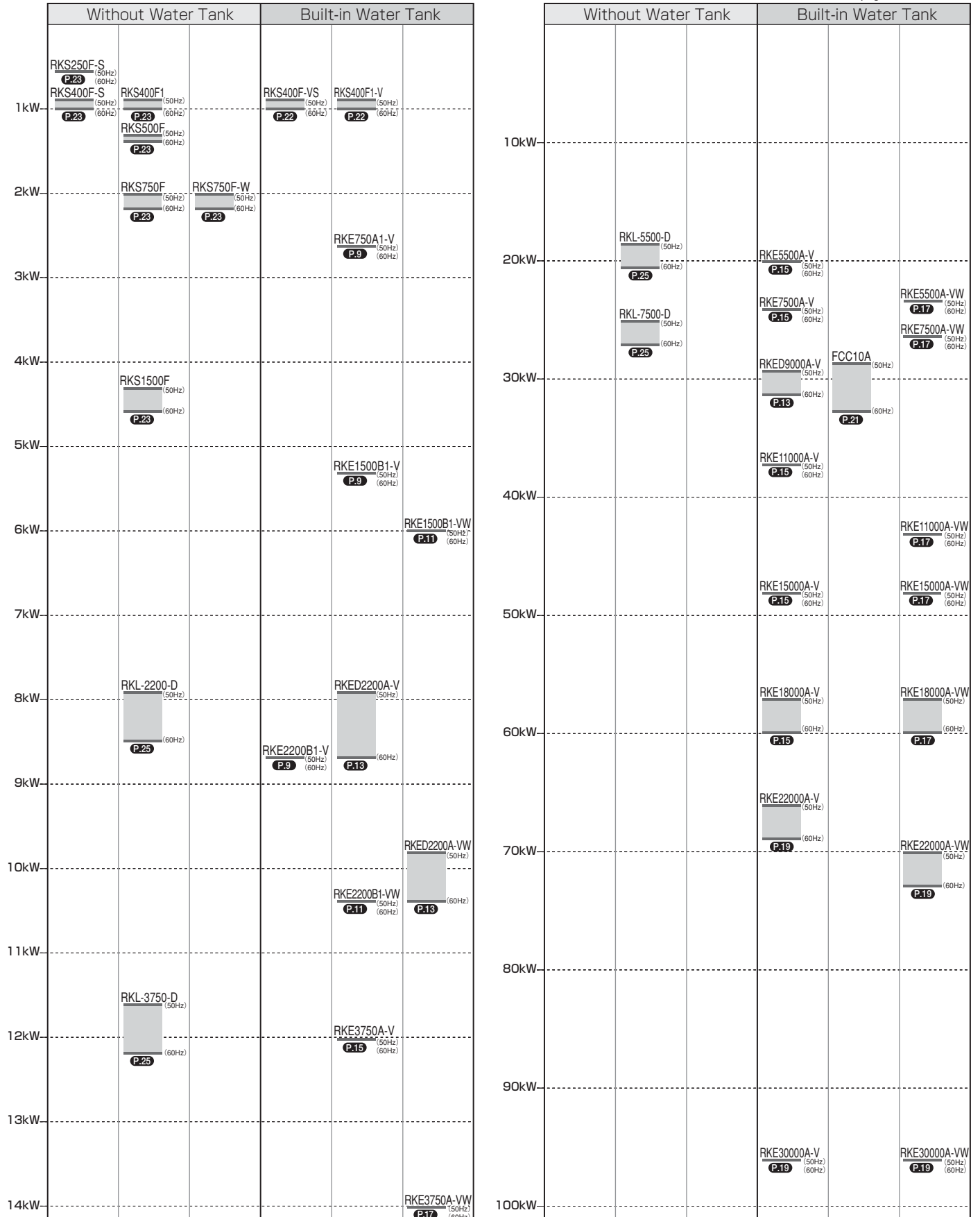



# Model & Series Configurations

Orion Chillers : Industrial Chillers with a Solid Record of Superior Reliability.

## With and Without a Water Tank

ORION Chillers can roughly be divided into two groups -- those with water tanks, and those without.

### With Built-in Water Tank (Closed loop system)

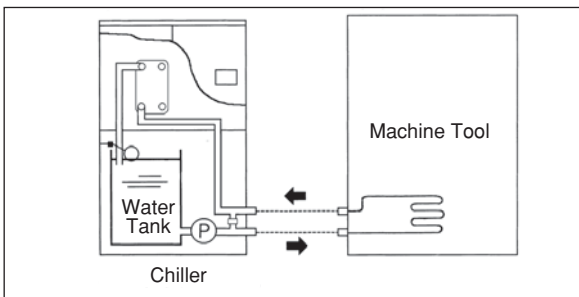

※ In addition to the discharge pump, models with built-in circulation pumps are also available. Please refer to the specifications of individual models for further details.

### Without Built-in Water Tank (Open loop system)

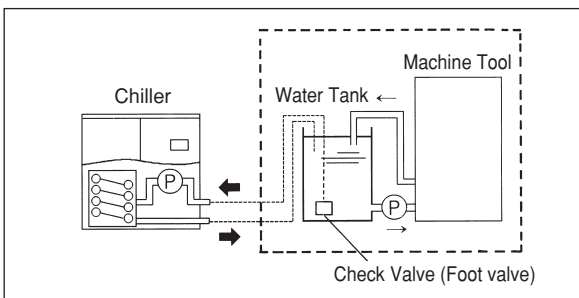

※ For models without built-in water tanks, a separate water tank must be installed. In such cases, the water tank must have a capacity suitable for the model of chiller it is to be used with. Please refer to the specifications of individual models for further details.

## Model Number Nomenclature

### RKS400F-VS

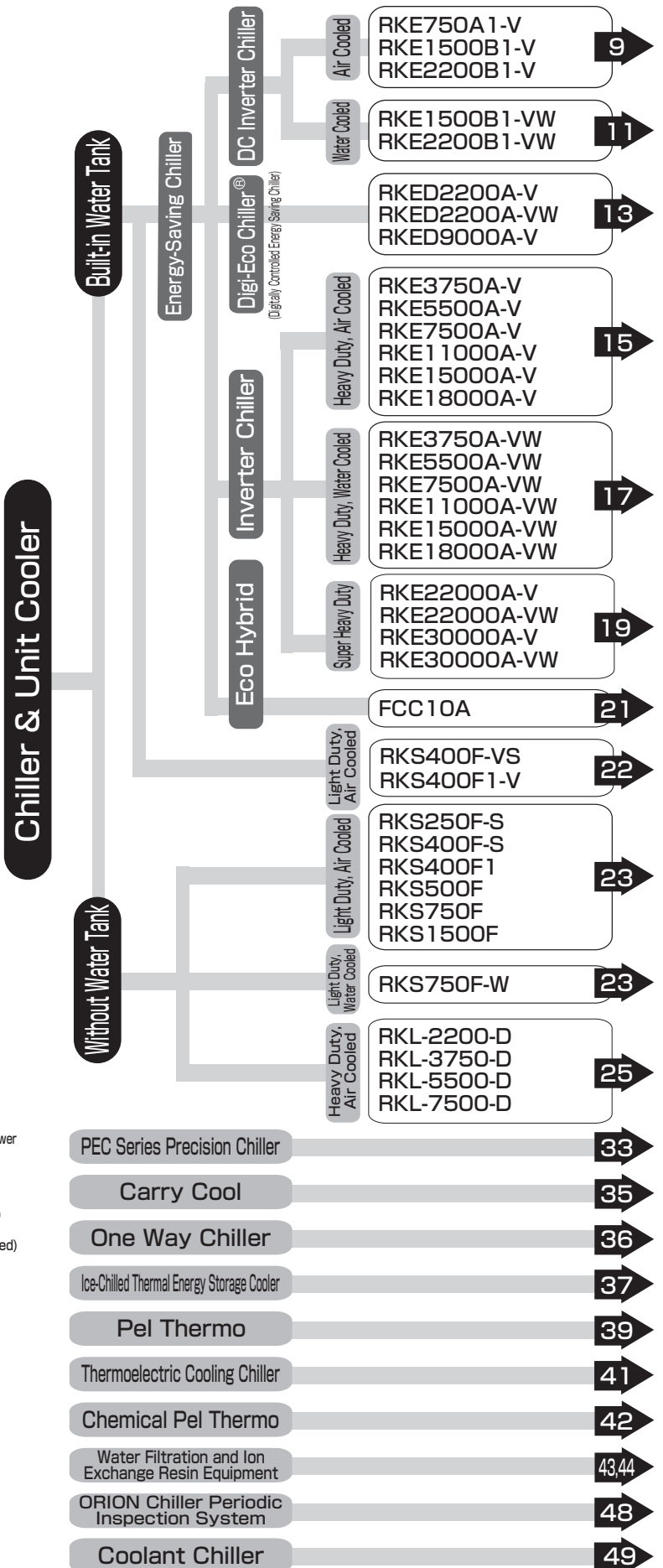
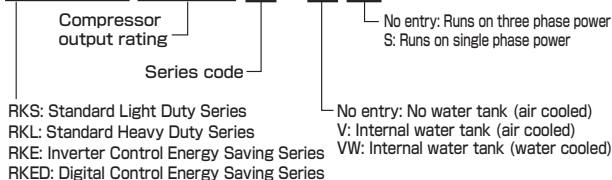

**Built-in Water Tank**

# Energy-Saving Chiller

**ORION**  
Patented

## DC Inverter Chiller-Air Cooled Series

Cooling capacity: 2.7 kW - 8.7 kW

Refrigeration Equipment

### Model Outline

- DC Motor Compressor Inverter Controlled
- Built-In Discharge Pump
- Digital Temperature Control
- External Warning Alarm Terminals Operation / Alarm / Remote operation
- Condenser Filter Included
- Rated for 3 Power Sources
- Freeze Prevention Mode (User selectable)
- IPX3 Equip. Rating Splash-proof
- Multi-Function Parameters

\* Only when the vent direction panel is installed on top of the unit. Except RKE2200B1-V

### Features

- 1. As much as 65% Energy Savings Possible**  
 Compared to previous models we've been able to achieve a 30% savings in energy while running at full loads. And we've been able to achieve up to 65% in energy savings over hot gas bypass control chillers. (RKE1500B1-V)
- 2. High Accuracy Temperature Control of ± 0.1°C**  
 Precise control even for applications that have severe temperature management requirements.
- 3. Compact design. Our DC Inverter Chiller is built to high specifications and engineered to make it as easy to use as possible.**  
 40% cut compared with the overall size of the RKED2200A-V. (RKE2200B1-V)  
 The water tank is at the perfect height making it easy to add water, perform quality checks, and cleaning.

- CE Marking  
Built to order  
Except RKE2200B1-V
- Multi-Directional Vent  
RKE750A1-V/1500B1-V
- High Efficiency Refrigerant R410A
- Warm-Up Mode
- External Communications Capability  
(Req. optional circuit board.)
- Remote Control Panel (Optional)



### Specifications

Item	Model	RKE750A1-V-G1 · G2 (w/casters)	RKE1500B1-V-G1 · G2 (w/casters)	RKE2200B1-V-G1 · G2 (w/casters)	
Performance specifications	Cooling capacity (at 20°C) ※1	kW	2.7	5.3	8.7
	Operable ambient temperature range	°C	-5~43		
	Operable temperature range (fluid temperature)	°C	5~35		
	Control accuracy ※4	°C	± 0.1°C (when load, ambient temperature, power source are stable) ±0.5°C (during continuous operation when load fluctuation stays within ±10%)		
Power specifications	Minimum operating circulation rate	L/min	10 (head: 20/30m)	12/21 (head: 50m)	28/43 (head: 50m)
	Power source ※2	V (Hz)	Three phase 200±10% (50/60)、220±10% (60)		
	Power consumption ※1	kW	1.2/1.3、1.3	2.3/2.4、2.4	4.6/4.7、4.7
	Electric current ※1	A	4.5/5.3、4.7	8.7/9.0、9.0	16/17、17
	Power capacity ※3	kVA	2.1	4.2	6.5
Breaker capacity	A	10 (15 when heater is installed) Sensitivity current30mA High-speed	15 (20 when heater is installed) Sensitivity current30mA High-speed	※6 30	
Operation control method		Compressor speed control			
Equipment details	Compressor	Fully sealed rotary type (inverter driven)			
	Condenser	Fin and tube forced air cooling			
	Heat exchanger	Construction	Plate type heat exchanger		
		Material	SUS316 grade stainless steel (brazing: copper)		
	Discharge pump	Construction	Cascade type		
		Output	kW	0.25	0.40
Water tank capacity	L	approx. 15		approx. 20	
Refrigerant		R-410A			
CE Marking		Available with special order		—	
Outside dimensions (H × D × W)	mm	G1 : 840×688×400 · G2 : 927×688×400	G1 : 879×850×400 · G2 : 966×850×400	G1 : 993×970×530 · G2 : 1080×970×530	
Unit mass (dry weight)	kg	G1 : 68 · G2 : 73	G1 : 96 · G2 : 100	G1 : 135 · G2 : 140	
Operating noise level ※5	dB	55/57	56/60	62/64	

※ 1 During operation when the fluid temperature is 20°C and the ambient temperature is 32°C . Cooling capacity will be at least 95% of the noted figures.  
 ※ 2 Source voltage phase unbalance should be less than ± 3%. ※ 3 The figure noted is when the equipment is operating at the highest capacity of its normal operating range.  
 ※ 4 Except when the cooling load is too small, in which case the compressor may cycle on and off. ※ 5 Operating noise levels are from a position of 1m in front of the unit and at a height of 1m. ※ 6 Unit comes with a built-in multi-purpose overload and short circuit protection breaker.  
 Note 1: The chilled fluid can be either potable water or a low concentration ethylene glycol water solution of 10% or less.  
 Note 2: Heat output of the equipment (in kW) is about 1.3 times the cooling capacity.

### Cooling Capacity

RKE750A1-V-G1·G2 RKE1500B1-V-G1·G2 RKE2200B1-V-G1·G2

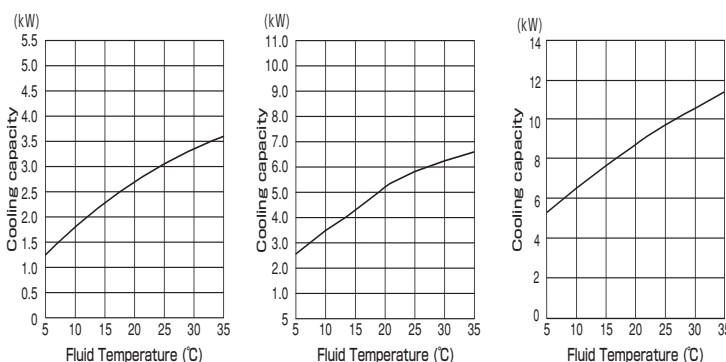

Conditions  
 · Ambient temperature: 32°C  
 · Fluid: Tap water

### Minimum Heat Requirement for Inverter Control

※ Even in the high accuracy mode, if the amount of heat to process is below the minimum level, the compressor will cycle ON and OFF, and may affect the control accuracy.  
 ※ If the minimum heat requirement for inverter control is not met and high accuracy temperature control is necessary, please install the optional heater assembly unit, or ask for a special model equipped with a capacity control valve.

RKE750A1-V-G1·G2 RKE1500B1-V-G1·G2 RKE2200B1-V-G1·G2

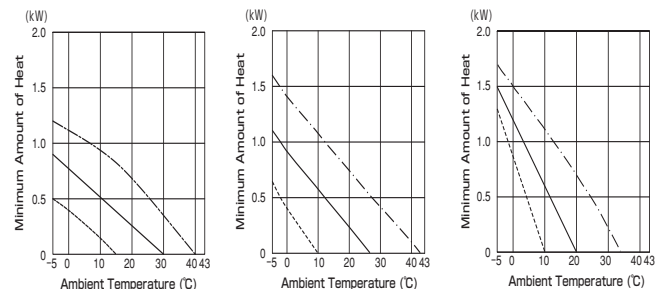

Conditions -- Cooling water: Tap water

## External dimensions

**RKE750A1-V-G1/G2 (w/casters)**

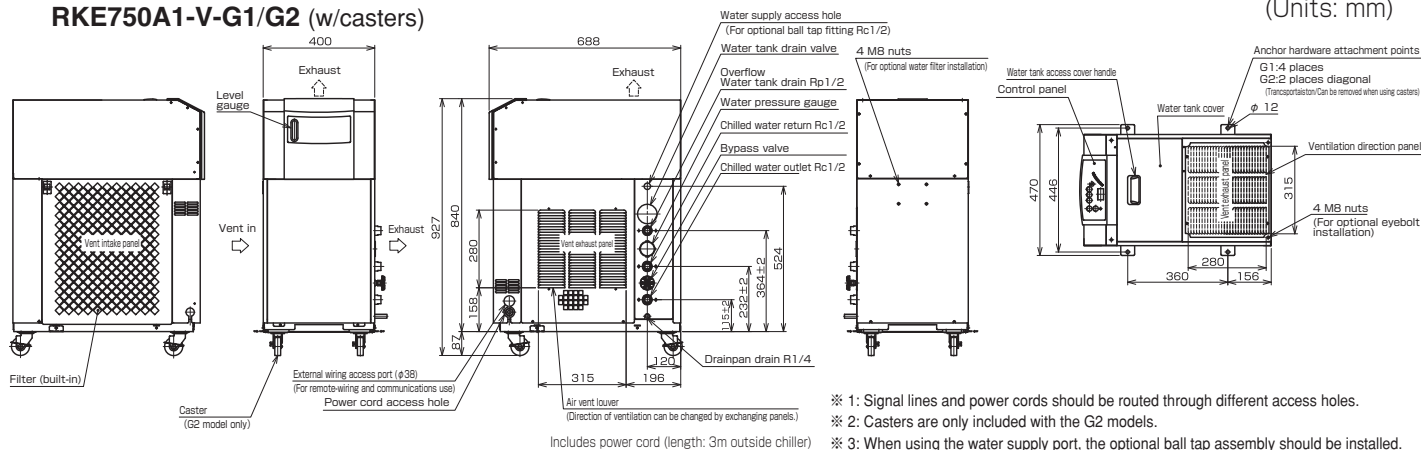

**RKE1500B1-V-G1/G2 (w/casters)**

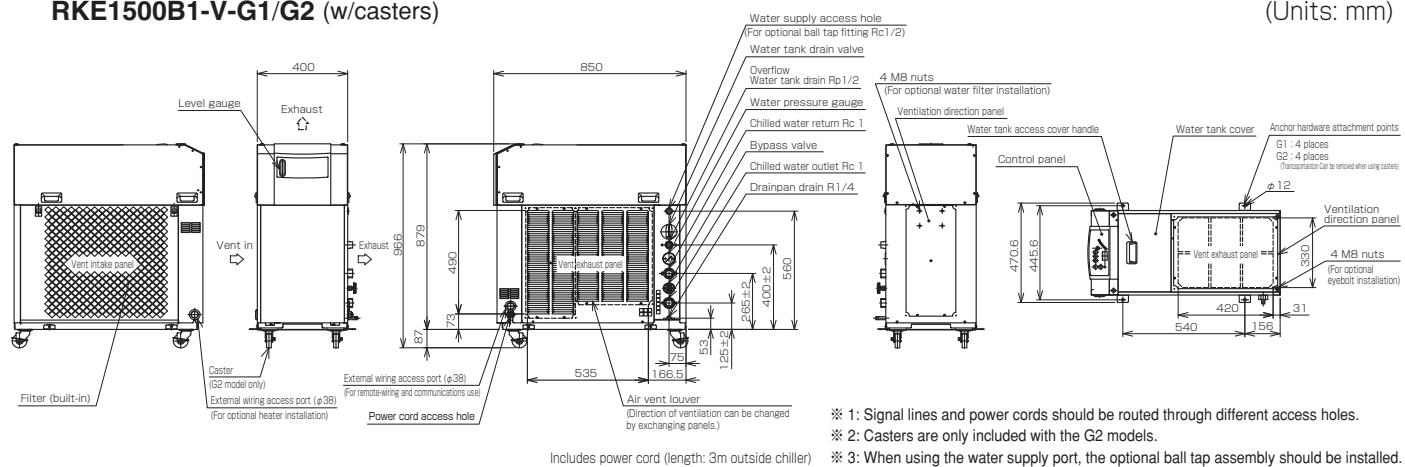

**RKE2200B1-V-G1/G2 (w/casters)**

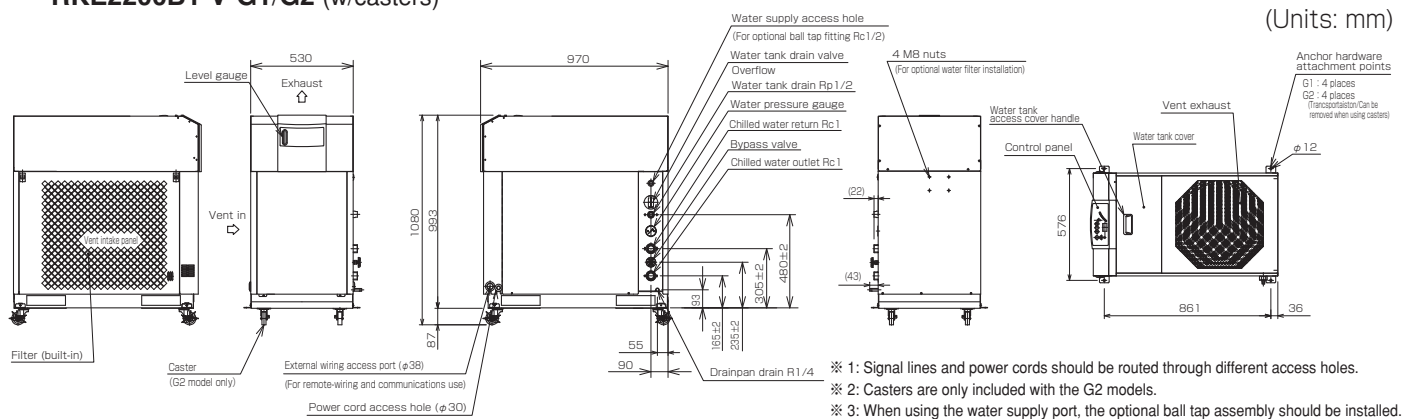

## Pump Characteristic Curves

Ratings for stand-alone pump operation.

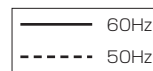

**RKE750A1-V-G1·G2**

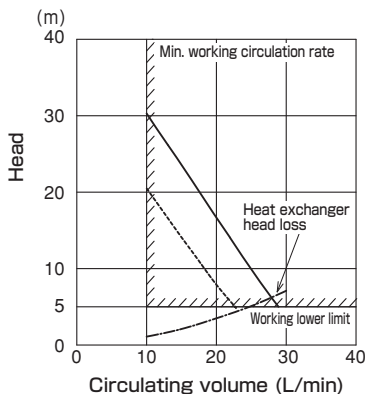

**RKE1500B1-V-G1·G2**

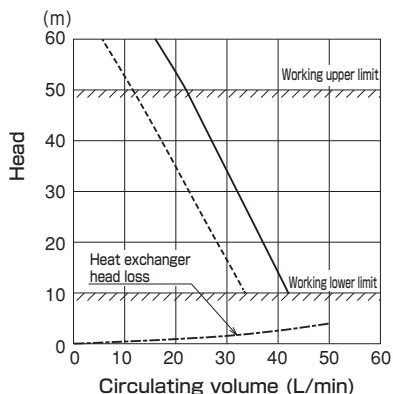

**RKE2200B1-V-G1·G2**

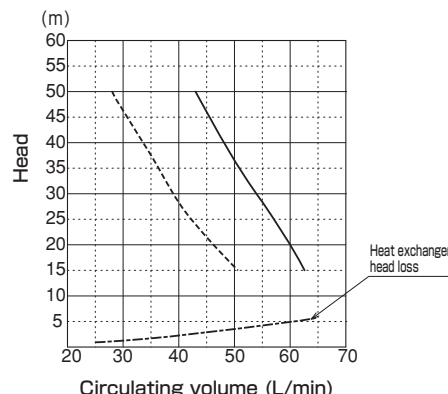

**Built-in Water Tank**

# Energy-Saving Chiller

**ORION**  
Patented

**DC Inverter Chiller - Water Cooled Series**

Cooling capacity: 6.0 kW - 10.4 kW Refrigeration Equipment

## Model Outline

DC Motor Compressor Inverter Controlled

Built-In Discharge Pump

Digital Temperature Control

External Warning Alarm Terminals Operation / Alarm / Remote operation

Rated for 3 Power Sources

Freeze Prevention Mode (User selectable)

IPX3 Equiv. Rating Splash-proof

Multi-Function Parameters

CE Marking

High Efficiency Refrigerant R410A

Warm-Up Mode

External Communications Capability

Remote Control Panel (Optional)

※Except RKE2200B1-VW

Except RKE2200B1-VW

(Req. optional circuit board.)

## Features

- 1. Maximum 65% energy savings possible.**  
Compared to previous models we've been able to achieve a 30% savings in energy while running at full loads. As much as 65% energy savings possible compared with HB control models. (RKE1500B1-VW)
- 2. High Accuracy Temperature Control of ± 0.1°C**  
Precise control even for applications that have severe temperature management requirements.
- 3. Compact design. Our DC Inverter Chiller is built to high specifications and engineered to make it as easy to use as possible.**  
40% cut compared with the overall size of the RKED2200A-VW. (RKE2200B1-VW)  
The water tank is at the perfect height making it easy to add water, perform quality checks, and cleaning.



## Specifications

Item		Model	RKE1500B1-VW-G1/G2 (w/casters)	RKE2200B1-VW-G1/G2 (w/casters)
Performance specifications	Cooling capacity (for chilled water temp. of 20°C) ※1	kW	6.0	10.4
	Ambient temp. range	°C	2~43	
	Operable temperature range (fluid temperature)	°C	5~35	
	Control accuracy ※4	°C	±0.1 (when load, ambient temperature, and power source are stable) ±0.5 (when continuous load fluctuation is within ±10%)	
Minimum operating circulation rate	L/min	12/21 (Head: 50m) / 28/43 (Head: 50m)		
Power specifications	Power source ※2	V (Hz)	Three-phase 200±10% (50/60), 220±10% (60)	
	Power consumption ※1	kW	1.7/1.8, 1.8 / 3.5/3.7, 3.7	
	Electric current ※1	A	6.5/7.1, 6.6 / 14/14, 14	
	Power capacity ※3	kVA	3.0 / 5.5	
Breaker capacity	A	15 (20 when heater is installed), current sensitivity: 30mA, high-speed type ※6 / 30		
Operation control method		Compressor speed control		
Compressor		Fully sealed rotary type (inverter driven)		
Condenser		Double pipe water cooling		
Unit specifications	Refrigeration unit	Construction	Plate type heat exchanger	
		Material	SUS316 grade stainless steel (brazing: copper)	
	Discharge pump	Construction	Cascade type	
		Output	kW	0.40
Water tank capacity	L	approx. 15 / approx. 20		
Refrigerant	R-410A			
CE Marking	Available with special order			
External dimensions (H×D×W)	mm	G1 : 879×850×400 · G2 : 966×850×400 / G1 : 993×970×530 · G2 : 1080×970×530		
Unit mass (dry weight)	kg	G1 : 95 · G2 : 98 / G1 : 135 · G2 : 140		
Operating noise level ※5	dB	55 / 59/60		

※1 Operation when chilled water temp. is 20°C and cooling water temp. is 32°C. Cooling capacity is at least 95% of listed figures. ※2 Source voltage phase unbalance should be less than ±3%.  
 ※3 The figure noted is when the equipment is operating at the highest capacity of its normal operating range. ※4 Except when the cooling load is too small, in which case the compressor may cycle on and off. ※5 Operating noise levels are from a position of 1m in front of the unit and at a height of 1m. ※6 Unit comes with a built-in multi-purpose overload and short circuit protection breaker. Note 1: The cooling fluid can be either tap water or a low concentration ethylene glycol water solution of 10% or less.

## Cooling Capacity

RKE1500B1-VW-G1·G2

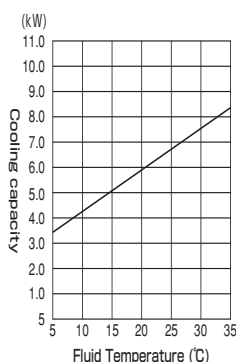

Conditions -- Cooling water temperature at inlet: 32°C. Chilled liquid: Tap water

RKE2200B1-VW-G1·G2

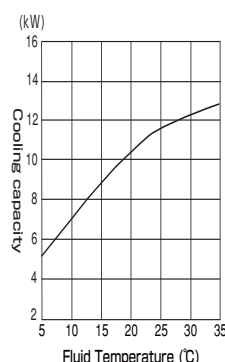

Conditions -- Cooling water temperature at inlet: 32°C. Chilled liquid: Tap water

## Minimum Heat Requirement for Inverter Control

※Even in the high accuracy mode, if the amount of heat to process is below the minimum level, the compressor will cycle ON and OFF, and may affect the control accuracy.  
 ※If the minimum heat requirement for inverter control is not met and high accuracy temperature control is necessary, please install the optional heater assembly unit, or ask for a special model equipped with a capacity control valve.

RKE1500B1-VW-G1·G2

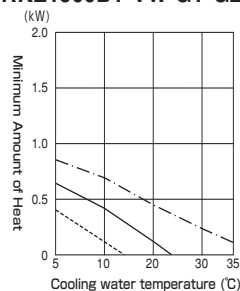

Conditions -- Chilled liquid: Tap water

RKE2200B1-VW-G1·G2

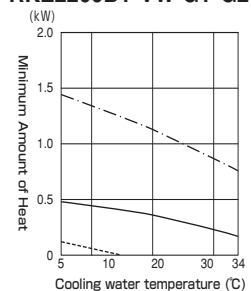

Conditions -- Chilled liquid: Tap water

## External dimensions

### RKE1500B1-VW-G1/G2 (w/casters)

(Units: mm)

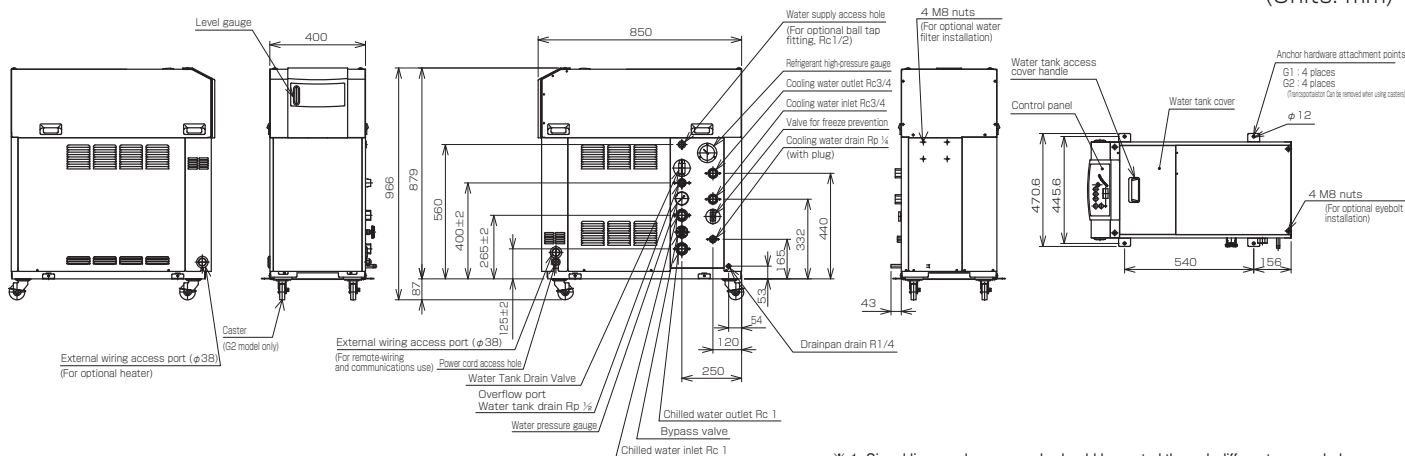

※ 1: Signal lines and power cords should be routed through different access holes.

※ 2: Casters are only included with the G2 model.

Includes power cord (length: 3m outside chiller) ※ 3: When using the water supply port, the optional ball tap assembly should be installed.

### RKE2200B1-VW-G1/G2 (w/casters)

(Units: mm)

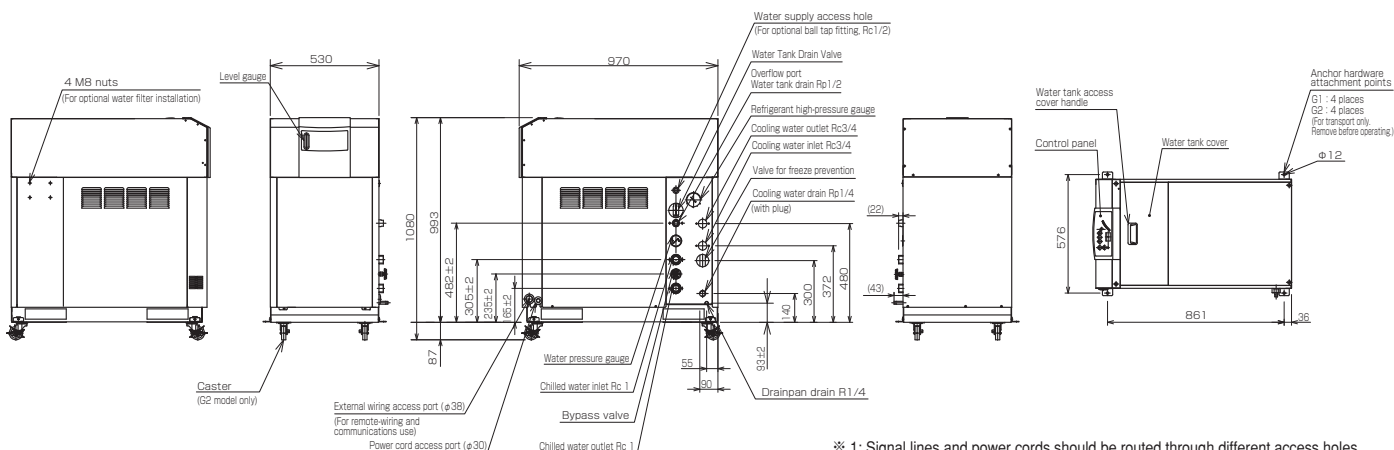

※ 1: Signal lines and power cords should be routed through different access holes.

※ 2: Casters are only included with the G2 model.

※ 3: When using the water supply port, the optional ball tap assembly should be installed.

## Pump Characteristic Curves Ratings for stand-alone pump operation.

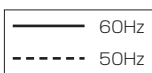

### RKE1500B1-VW-G1·G2

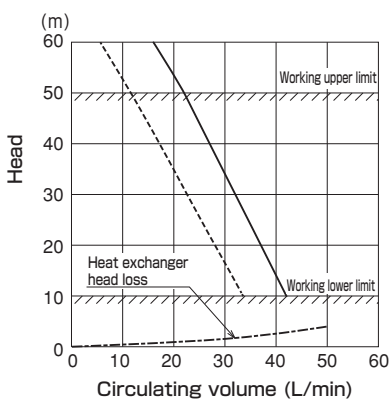

### RKE2200B1-VW-G1·G2

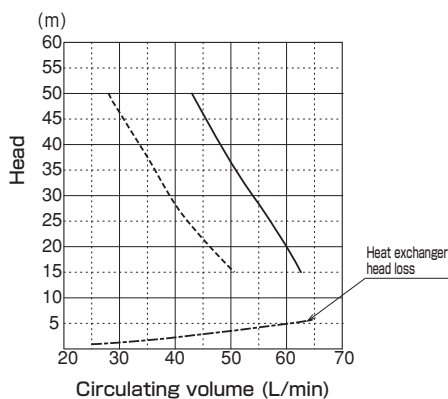

## Cooling Water Flow Rate (for condenser)

### RKE1500B1-VW-G1·G2

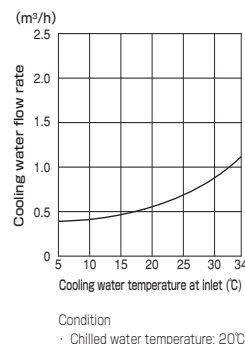

### RKE2200B1-VW-G1·G2

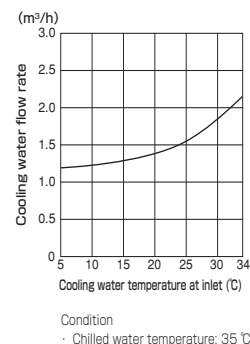

**Built-in Water Tank**

# Energy-Saving Chiller

**ORION**

Patented

**Digi-Eco Chiller®**

Cooling capacity: 7.9 kW - 31.4 kW Refrigeration Equipment

## Model Outline

Digitally Controlled Compressor	Built-In Discharge Pump	Digital Temperature Control	External Warning Alarm Terminals Operation / Alarm / Remote operation	Condenser Filter Included (Air cooled model)	Rated for 3 Power Sources	Freeze Prevention Mode (User selectable)	IPX4 Equiv. Rating Splash-proof	Multi-Function Parameters
---------------------------------	-------------------------	-----------------------------	---	--	---------------------------	--	---------------------------------	---------------------------

## Features

- Huge energy savings of up to 65% over inverter-only controlled models.** Patented  
Using Orion's original digital control (LOAD/UNLOAD) technology, our chiller achieves significant energy savings across the entire spectrum of loads from 0% to 100%.
- Both Energy Savings AND Precision Control, even under low loads.**  
Orion has managed to achieve what was previously unattainable -- reliable energy savings at low working loads (below 30%) along with high accuracy operation.
- Safe and Reliable Design**  
Our chillers are reliable thanks to the simplicity of the components used. And yet we also offer advanced features such as computer based control and monitoring.



RKED2200A-V

## Specifications

Item	Model	Air cooled model		Water cooled model	
		RKED2200A-V		RKED2200A-VW	RKED9000A-V
Performance specifications	Cooling capacity (50/60Hz) ※ 1	kW	7.9/8.7	9.8/10.4	29.2/31.4
	Operable ambient temperature range	°C	-5~43	2~43	-5~43
	Operable temperature range (fluid temperature)	°C		5~35	
	Control accuracy ※ 4		± 1.0°C (during periods of a stable load: ± 0.5°C)		
Power specifications	Power source ※ 2	V (Hz)	Three phase 200 ± 10% (50/60) , 220 ± 10% (60)		
	Power consumption (50/60Hz, 220V)※1	kW	3.5/4.6, 4.6	2.9/3.7, 3.7	14/17, 17
	Electric current (50/60Hz, 220V)※1	A	12.9/15.2, 15.0	11.3/12.8, 12.6	45/52, 52
	Power capacity ※3	kVA		6.9	20
	Breaker capacity	A		30	※7 75
Equipment details	Condenser		Fin and tube forced air cooling	Double pipe water cooling	Fin and tube forced air cooling
	Heat exchanger	Construction	Plate type heat exchanger		
		Material	SUS316 grade stainless steel (brazing: copper)		
	Discharge pump ※5	Output	kW	0.75	2.2
		Flow rate (50/60Hz)	L/min	28/43 (Head: 50m)	60/125 (Head: 50m)
	Fan motor output	W	100 (inverter driven)	—	750 (inverter driven)
	Water tank capacity	L	Approx. 95		
	Refrigerant control method		Electronic expansion valve (controlled by stepping motor)		
Refrigerant		R-407C			
Outside dimensions (H×D×W)	mm	1440×730×960		1800×850×1200	
Unit mass (dry weight)	kg	240	230	435	
Operating noise level (50/60Hz) ※6	dB	62/67	59/63	69/71	

※ 1 Operation when chilled water temp. is 20°C and cooling water temp. is 32°C. Cooling capacity is at least 95% of listed figures. ※ 2 Source voltage phase unbalance should be less than ±3%. ※ 3 The figure noted is when the equipment is operating at the highest capacity of its normal operating range. ※ 4 Stable load indicates continued operation with maximum load fluctuations of ± 10% of the current load. ※ 5 The capacity figures listed represent just one point on this model's flow-rate/head characteristic curve. Pumps differ between models; for model specific details, please refer to the pump characteristic curves. ※ 6 Operating noise levels are from a position of 1m in front of the unit and at a height of 1m. ※ 7 Unit comes with a built-in multi-purpose overload and short circuit protection breaker. Note 1: The chilled fluid can be either potable water or a low concentration ethylene glycol water solution of 10% or less. Note 2: Please install the included strainer (40 mesh) to the fluid intake port. Note 3: Heat output of the equipment (in kW) is about 1.3 times the cooling capacity. (air cooled models only)

## Cooling Capacity

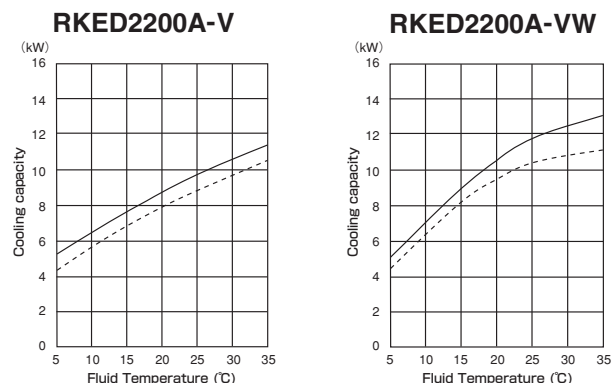

Conditions  
 · Ambient temperature: 32°C  
 · Fluid: Tap water

Conditions  
 · Ambient temperature: 32°C  
 · Fluid: Tap water

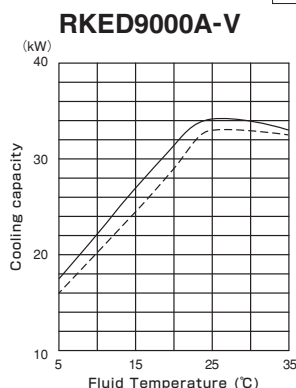

Conditions  
 · Ambient temperature: 32°C  
 · Fluid: Tap water

## Cooling Water Flow Rate (for condenser)

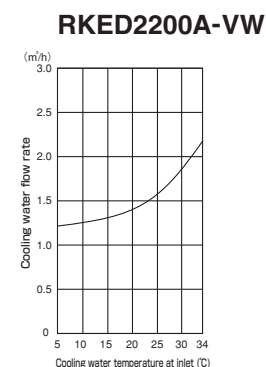

Condition · Chilled water temperature: 35°C

## External dimensions

### RKED2200A-V

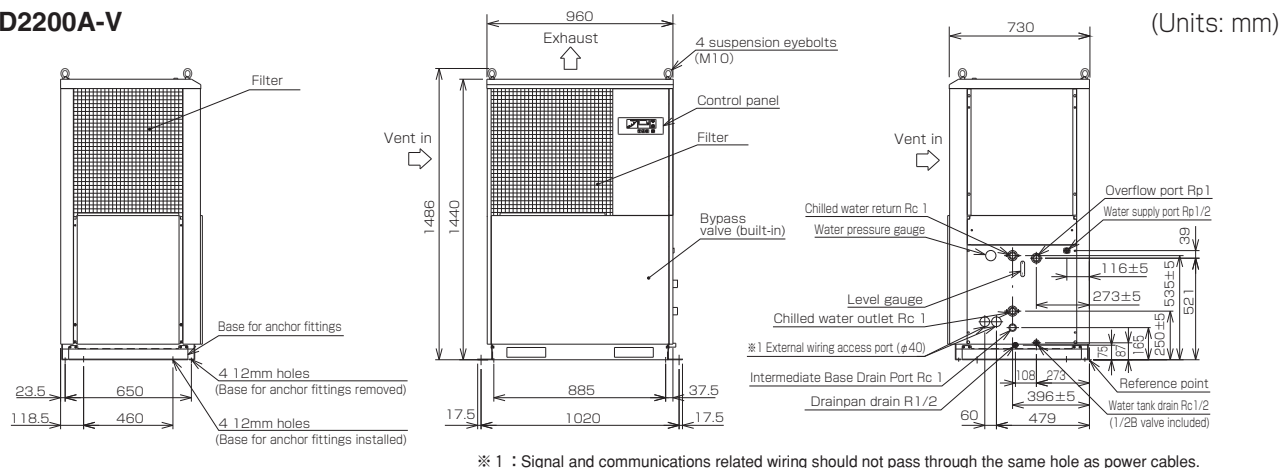

### RKED2200A-VW

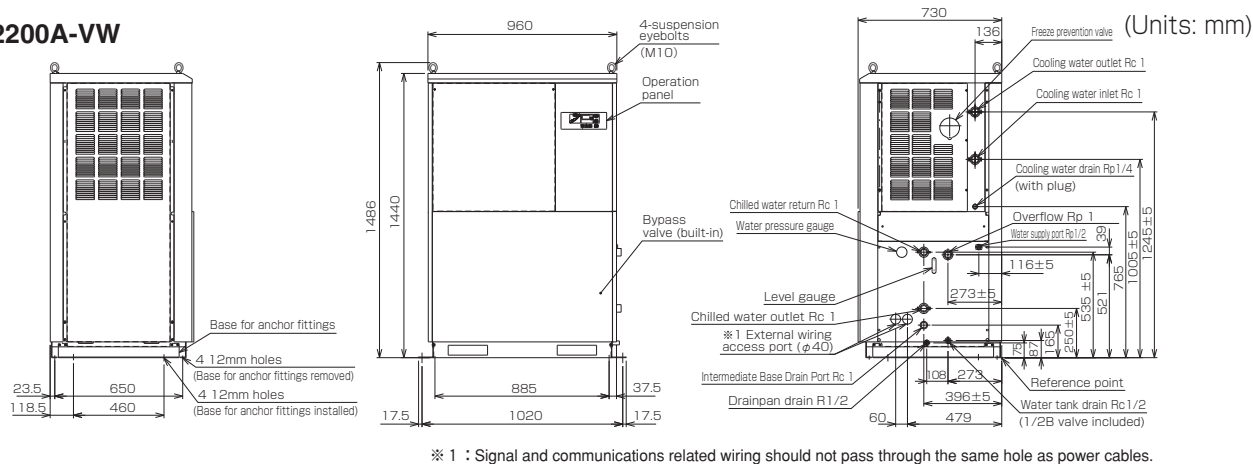

### RKED9000A-V

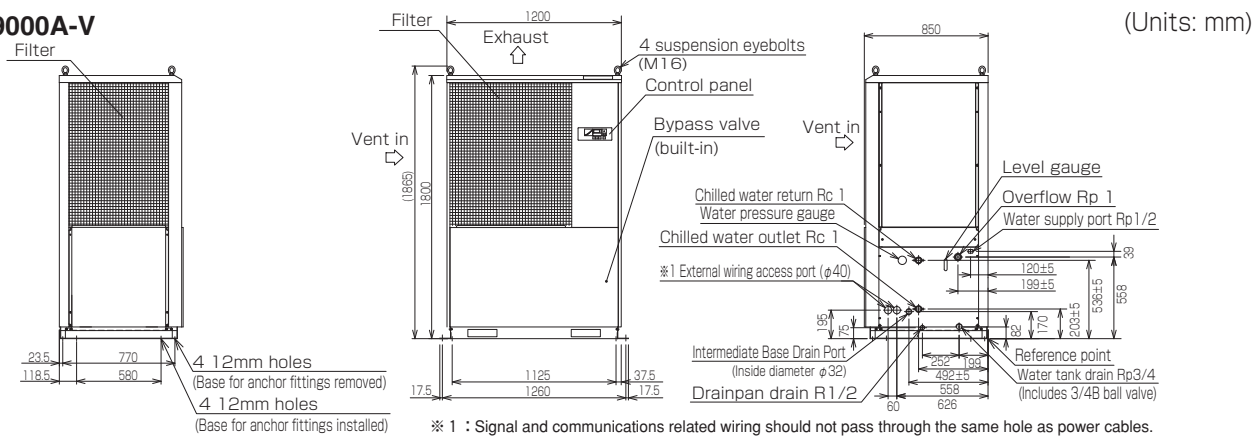

## Pump Characteristic Curves

Ratings for stand-alone pump operation.

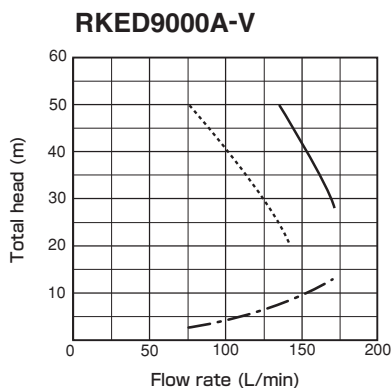
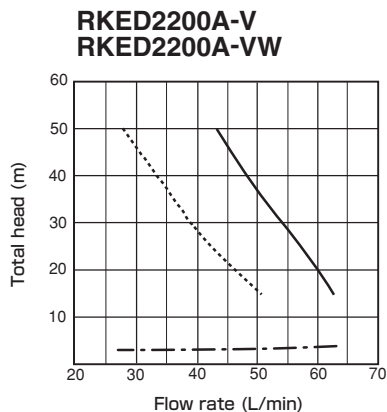

— 60Hz  
- - - 50Hz  
- · - · Heat exchanger head loss  
※ When looking up the flow rate and pressure, be sure to add in resistance from external piping to the value of the heat exchanger head loss.

**Built-in Water Tank**

# Energy-Saving Chiller

**ORION**

Patented

Heavy Duty Inverter Chiller -- Air Cooled Series

Cooling capacity: 12.2 kW - 57/60 kW Refrigeration Equipment

## Model Outline

- Digitally Controlled Compressor
- Built-In Discharge Pump
- Digital Temperature Control
- External Warning Alarm Terminals Operation / Alarm / Remote operation
- Condenser Filter Included
- Rated for 3 Power Sources
- Freeze Prevention Mode (User selectable)
- IPX4 Equiv. Rating Splash-proof
- Multi-Function Parameters
- HFC Refrigerant R407C
- Warm-Up Mode
- External Communications Capability
- 50/60Hz Same Power Output  
(Except RKE18000A-V)
- Remote Control Panel (Optional)

## Features

1. Operates with a maximum energy savings of 57%. \*  
These Orion chillers respond to work loads using the least amount of energy.  
(\* Compared with HB control models running at a 30% load)
2. Highly accurate fluid temperature control possible. Patented  
The chiller senses the fluid temperature and adjusts the compressor speed accordingly, thus achieving fluid temperature precision control of  $\pm 0.2 \sim \pm 1.0^\circ\text{C}$ . (Accuracy is subject to work loads. Please consult your dealer if high accuracy is demanded.)
3. Wide range of fluid temperature control.  
User settings of fluid temperatures between  $5 \sim 35^\circ\text{C}$  are now possible.
4. Adopted for use with environmentally friendly refrigerant.  
Uses non ozone-depleting R407C refrigerant.
5. Comes with built-in communications interface as standard equipment.  
Allows temperature control via RS232C or RS422 interfaces.



RKE3750A-V

\*Digit-Eco Chiller  
RKED9000A-V

RKE18000A-V

## Specifications

Item	Model	Air cooled							
		RKE3750A-V	RKE5500A-V	RKE7500A-V	RKE11000A-V	RKE15000A-V	RKE18000A-V		
Performance specifications	Cooling capacity (50/60Hz)*1	kW	12.2	20.3	25.0	37.2	48.0	57/60	
	Operable ambient temperature range	°C	-5~43						
	Operable temperature range(fluid temperature)	°C	5~35						
Power specifications	Control accuracy **4		Under high accuracy setting $\pm 1.0^\circ\text{C}$ ( $\pm 0.5^\circ\text{C}$ during stable load), under energy-saving setting $\pm 1.0^\circ\text{C}$ ( $\pm 0.5^\circ\text{C}$ during stable load, $\pm 2.0^\circ\text{C}$ during ON/OFF cycle mode)			Under high accuracy setting $\pm 1.0^\circ\text{C}$ ( $\pm 0.5^\circ\text{C}$ during stable load), under energy-saving setting $\pm 1.0^\circ\text{C}$ ( $\pm 0.5^\circ\text{C}$ during stable load, $\pm 2.0^\circ\text{C}$ during ON/OFF cycle mode)			
	Power source **2	V (Hz)	Three phase 200 $\pm$ 10% (50/60) , 220 $\pm$ 10% (60)			Three phase 200 $\pm$ 10% (50/60) , 220 $\pm$ 10% (60)			
	Power consumption(50/60Hz, 220V)*1	kW	5.2/5.5, 5.5	10.4/11.4, 11.4	11.4/12.1, 12.1	22.1/22.1, 22.1	22.8/22.8, 22.8	25.5/28.0, 28.0	
	Electric current(50/60Hz, 220V)*1	A	16.5/17.5, 17.5	35/39, 39	37.5/40.0, 40.0	72.5/72.5, 72.5	75/75, 75	82.2/89.8, 89.8	
	Power capacity **3	kVA	6.9	13.5	14.2	26.7	28	35	
	Breaker capacity	A	30	50	50	*7 100	*7 100	*7 125	
	Equipment details	Condenser	Fin and tube forced air cooling						
		Heat exchanger	Construction	Plate type heat exchanger					
			Material	SUS316 grade stainless steel (brazing: copper)					
		Discharge pump	Output	kW	0.75	2.2	2.2	2.2(inverter driven)	3.2(inverter driven)
Flow rate**5			L/min	28/43(Head: 50m)	60/125(Head: 50m)	60/125(Head: 50m)	140(Head: 50m)	200(Head: 50m)	200(Head: 50m)
Fan motor output		W	200(inverter driven)	750 (inverter driven)		750 $\times$ 2 (inverter driven)			
Water tank capacity		L	Approx. 95	Approx. 140	Approx. 140	Approx. 180	Approx. 160	Approx. 160	
Refrigerant		R-407C							
Outside dimensions (HxDxW)	mm	1440x730x960	1590x850x1200	1800x850x1200	1800x930x1440	1800x960x1720	1800x960x1720		
Unit mass (dry weight)	kg	Approx. 260	Approx. 370	Approx. 385	Approx. 545	Approx. 580	Approx. 660		
Operating noise level **6	dB	65	68	68	69	69	69		

See pages 13 and 14 for specifications

\*1 During operation when the fluid temperature is 20°C and the ambient temperature is 32°C. Cooling capacity will be at least 95% of the noted figures. \*2 Source voltage phase unbalance should be less than  $\pm 3\%$ . \*3 The figure noted is when the equipment is operating at the highest capacity of its normal operating range. \*4 Stable load indicates continued operation with maximum load fluctuations of  $\pm 10\%$  of the current load. \*5 Please operate with a head of 50m or less. \*6 Operating noise levels are from a position of 1m in front of the unit and at a height of 1m. \*7 Unit comes with a built-in multi-purpose overload and short circuit protection breaker. Note 1: Please install the included strainer (40 mesh) to the fluid intake port. Note 2: The chilled fluid can be either potable water or a low concentration ethylene glycol water solution of 10% or less. Note 3: Heat output of the equipment (in kW) is about 1.3 times the cooling capacity. Note 4: RKE15000A-V and RKE18000A-V models are built to order items.

## Cooling Capacity

RKE3750 / 5500 / 7500A-V

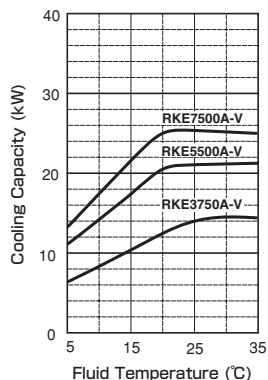

RKE11000  
15000  
18000A-V

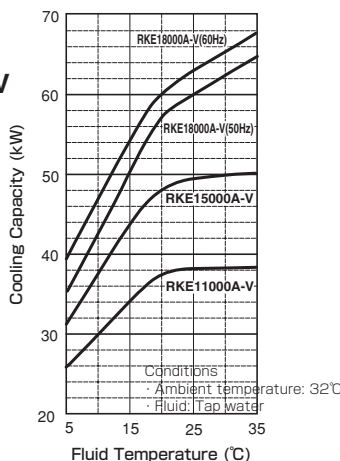

Conditions  
· Ambient temperature: 32°C  
· Fluid: Tap water

Conditions  
· Ambient temperature: 32°C  
· Fluid: Tap water



**External dimensions**

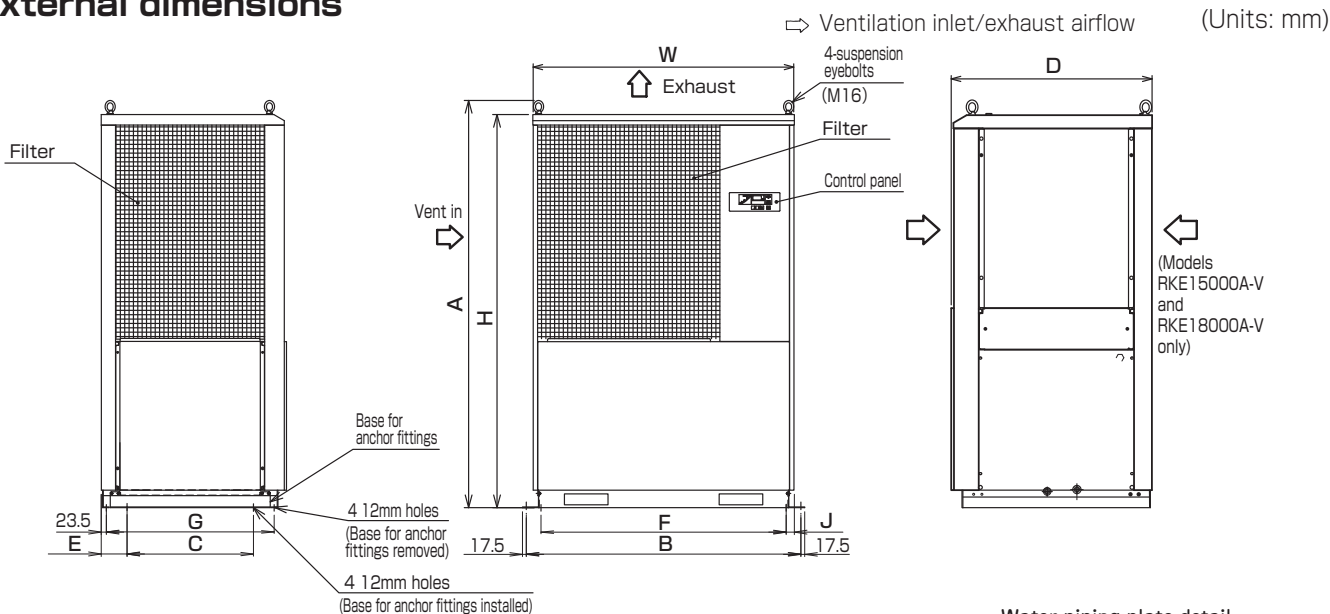

Model	H	D	W	A	B	C	E	G	F	J
RKE3750A-V	1440	730	960	1486	1020	460	118.5	650	885	37.5
RKE5500A-V	1590	850	1200	1655	1260	580	118.5	770	1125	37.5
RKE7500A-V	1800	850	1200	1865	1260	580	118.5	770	1125	37.5
RKE11000A-V	1800	930	1440	1865	1500	660	118.5	850	1365	37.5
RKE15000A-V	1800	960	1720	1865	1780	655	134.8	—	—	—
RKE18000A-V	1800	960	1720	1865	1780	655	134.8	—	—	—

Water piping plate detail

**RKE3750A-V**

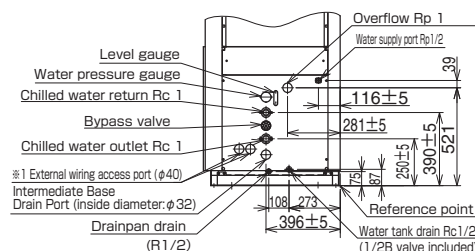

**RKE15000A-V / 18000A-V**

**RKE11000A-V**

**RKE5500A-V / 7500A-V**

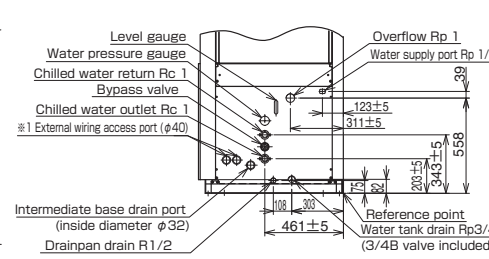
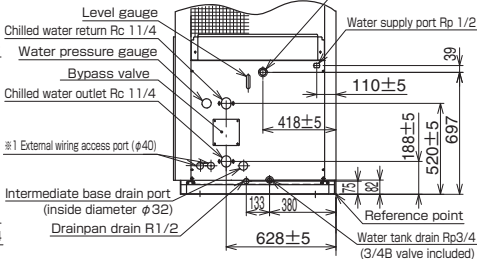
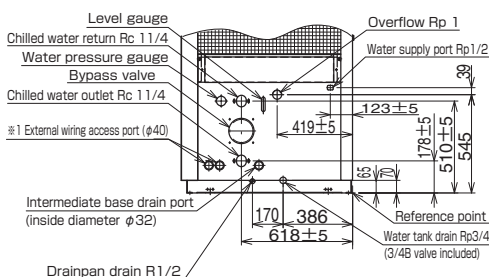

※ 1 : Signal and communications related wiring should not pass through the same hole as power cables.

**Pump Characteristic Curves**

- - - 60Hz (Flow rate for stand-alone pump operation)  
 - - - 60Hz (Flow rate including heat exchanger head loss)  
 - - - 50Hz (Flow rate for stand-alone pump operation)  
 - - - 50Hz (Flow rate including heat exchanger head loss)

- - - Flow rate for stand-alone pump operation  
 - - - Flow rate including heat exchanger head loss  
 Power frequency: 50/60Hz

**RKE3750A-V**

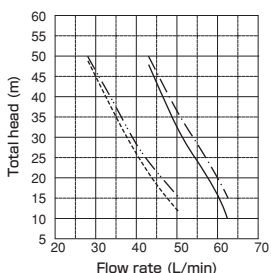

1. Internal (return side) head loss: 0.2m or less.

**RKE5500A-V / 7500A-V**

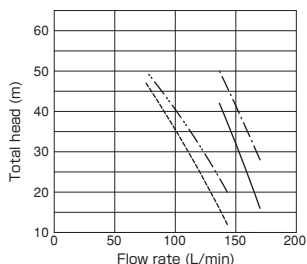

1. Internal (return side) head loss: 0.7m or less.

**RKE11000A-V**

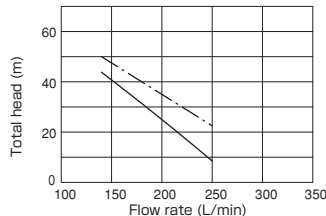

1. Internal (return side) head loss: 0.7m or less.

**RKE15000A-V**

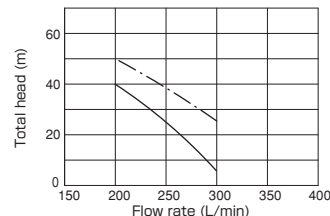

1. Internal (return side) head loss: 0.7m or less.

**RKE18000A-V**

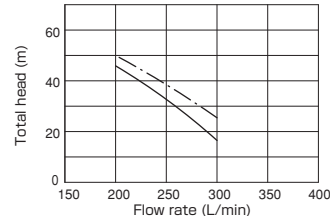

1. Internal (return side) head loss: 0.7m or less.

**Built-in Water Tank**

# Energy-Saving Chiller

**ORION**

Patented

## Heavy Duty Inverter Chiller -- Water Cooled Series

Cooling capacity: 14.1 kW - 57/60 kW

Refrigeration Equipment

### Model Outline

Digitally Controlled Compressor	Built-In Discharge Pump	Digital Temperature Control	External Warning Alarm Terminals Operation / Alarm / Remote operation	Rated for 3 Power Sources	Freeze Prevention Mode (User selectable)	IPX4 Equiv. Rating Splash-proof	Multi-Function Parameters	External Communications Capability
					HFC Refrigerant R407C	Warm-Up Mode	50/60Hz Same Power Output	Remote Control Panel (Optional)

### Features

- Operates with a maximum energy savings of 57%. \***  
Orion chillers respond to work loads using the least amount of energy.  
(\* Compared with HB control models running at a 30% load)
- Highly accurate fluid temperature control possible. (Patented)**  
The chiller senses the fluid temperature and adjusts the compressor speed accordingly, thus achieving fluid temperature precision control of  $\pm 0.2 \sim \pm 1.0^\circ\text{C}$ . (Accuracy is subject to work loads. Please consult your dealer if high accuracy is demanded.)
- Wide range of fluid temperature control.**  
User settings of fluid temperatures between  $5 \sim 35^\circ\text{C}$  are now possible.
- Adopted for use with environmentally friendly refrigerant.**  
Uses non ozone-depleting R407C refrigerant.
- Comes with built-in communications interface as standard equipment.**  
Allows temperature control via RS232C or RS422 interfaces.

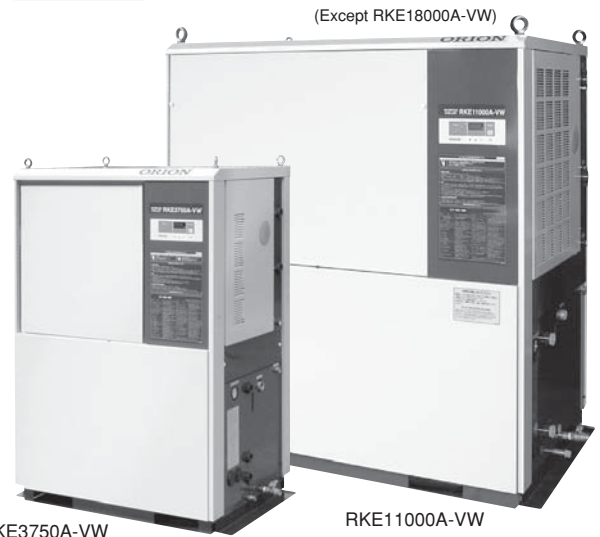

### Specifications

Item	Model	Water cooled							
		RKE3750A-VW	RKE5500A-VW	RKE7500A-VW	RKE11000A-VW	RKE15000A-VW	RKE18000A-VW		
Performance specifications	Cooling capacity (50/60Hz) *1	kW	14.1	23.4	27.3	43.0	48.0	57/60	
	Operable ambient temperature range	$^\circ\text{C}$	2~43						
	Operable temperature range (fluid temperature)	$^\circ\text{C}$	5~35						
	Control accuracy *4	Under high accuracy setting $\pm 1.0^\circ\text{C}$ ( $\pm 0.5^\circ\text{C}$ during stable load), under energy-saving setting $\pm 1.0^\circ\text{C}$ ( $\pm 0.5^\circ\text{C}$ during stable load, $\pm 2.0^\circ\text{C}$ during ON/OFF cycle mode)							
Power specifications	Power source *2	V (Hz)	Three phase 200 $\pm 10\%$ (50/60) , 220 $\pm 10\%$ (60)						
	Power consumption (50/60Hz, 220V) *1	kW	5.7/6.0, 6.0	10.7/11.7, 11.7	11/12, 12	19/19, 19	21/21, 21	23/25, 25	
	Electric current (50/60Hz, 220V) *1	A	18.2/19.2, 19.2	32.9/36.9, 36.9	34/37, 37	63/63, 63	68/68, 68	72/80, 80	
	Power capacity *3	kVA	6.9	13.5	13.9	26	27	32	
	Breaker capacity	A	30	50	50	*7 100	*7 100	*7 125	
Equipment details	Condenser		Double pipe water cooling						
	Heat exchanger	Construction	Plate type heat exchanger						
		Material	SUS316 grade stainless steel (brazing: copper)						
	Discharge pump	Output	kW	0.75	2.2	2.2	2.2 (inverter driven)	3.2 (inverter driven)	3.2 (inverter driven)
		Flow rate *5	L/min	28/43 (Head: 50m)	60/125 (Head: 50m)	60/125 (Head: 50m)	140 (Head: 50m)	200 (Head: 50m)	200 (Head: 50m)
Water tank capacity	L	Approx. 95	Approx. 140	Approx. 140	Approx. 160	Approx. 160	Approx. 160		
Refrigerant		R-407C							
Outside dimensions (HxDxW)	mm	1440x730x960	1590x850x1200	1590x850x1200	1590x930x1440	1590x930x1440	1580x960x1720		
Unit mass (dry weight)	kg	280	380	390	510	530	610		
Operating noise level *6	dB	58	58	58	59	59	60		

\* 1 During operation when fluid temperature is  $20^\circ\text{C}$  and cooling water temperature is  $32^\circ\text{C}$ . Cooling capacity is at least 95% of listed figures. \* 2 Source voltage phase unbalance should be less than  $\pm 3\%$ . \* 3 The figure noted is when the equipment is operating at the highest capacity of its normal operating range. \* 4 Stable load indicates continued operation with maximum load fluctuations of  $\pm 10\%$  of the current load. (However, this is excluding loads in the 25% to 40% range.) Setting can be changed by adjusting parameter F15. (Default setting is the high-accuracy setting.) \* 5 Please operate with a head of 50m or less. \* 6 Operating noise levels are from a position of 1m in front of the unit and at a height of 1m. \* 7 Unit comes with a built-in multi-purpose overload and short circuit protection breaker. Note 1: Please install the included strainer (40 mesh) to the fluid intake port. Note 2: The chilled fluid can be either potable water or a low concentration ethylene glycol water solution of 10% or less. Note 3: RKE15000A-VW and RKE18000A-VW models are built to order items.

### Cooling Capacity

RKE3750 / 5500 / 7500A-VW

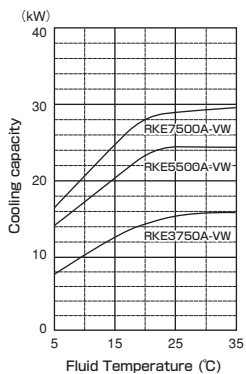

Conditions - Cooling water temperature at inlet:  $32^\circ\text{C}$ . Chilled liquid: Tap water

RKE11000 / 15000 / 18000A-VW

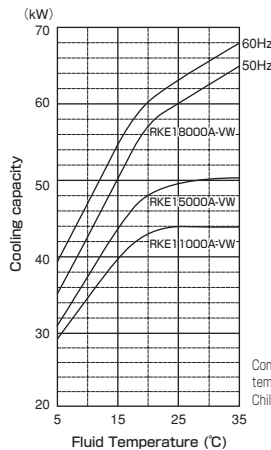

Conditions - Cooling water temperature at inlet:  $32^\circ\text{C}$ . Chilled liquid: Tap water

### Cooling Water Flow Rate (for condenser)

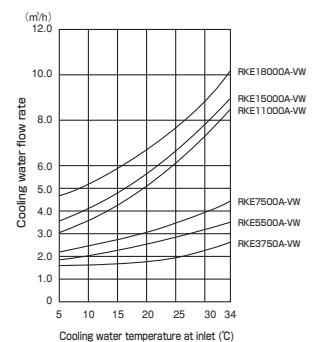

**External dimensions**

(Units: mm)

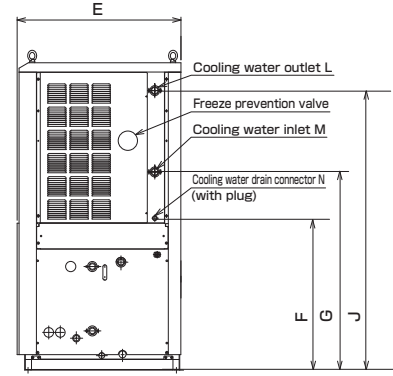
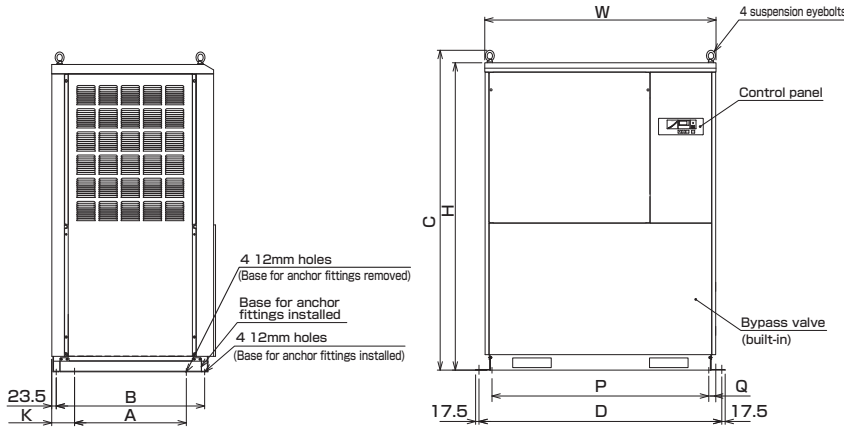

Water piping plate detail

Dimension Model	H	D	W	A	B	C	E	F	G	J	K	L, M	N	P	Q
RKE3750A-VW	1440	1020	960	460	650	1486	730	765	1005±5	1245±5	118.5	Rc1	Rp1/4	885	37.5
RKE5500A-VW	1590	1260	1200	580	770	1655	850	786	1025±5	1446±5	118.5	Rc1	Rp3/8	1125	37.5
RKE7500A-VW	1590	1260	1200	580	770	1655	850	786	1025±5	1446±5	118.5	Rc1	Rp3/8	1125	37.5
RKE11000A-VW	1590	1500	1440	660	850	1655	930	790	1053±5	1449±5	118.5	Rc1-1/4	Rp1/2	1365	37.5
RKE15000A-VW	1590	1500	1440	660	850	1655	930	800	1068±5	1449±5	118.5	Rc1-1/2	Rp1/2	1365	37.5
RKE18000A-VW	1580	1780	1720	655	—	1645	960	790	1058±5	1439±5	134.8	Rc1-1/2	Rp3/8x2	—	—

**RKE3750A-VW**

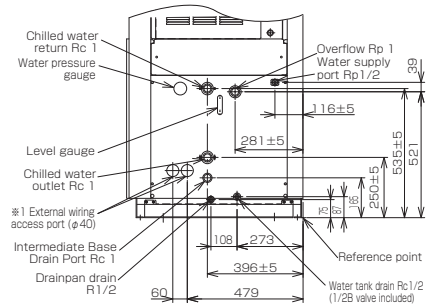

**RKE5500 / 7500A-VW**

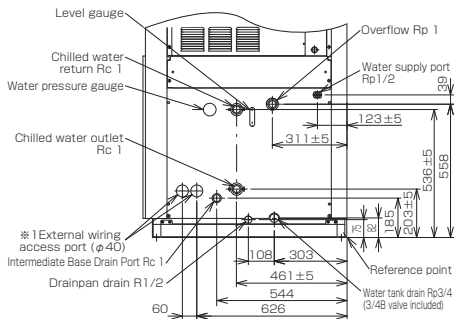

**RKE11000/15000A-VW**

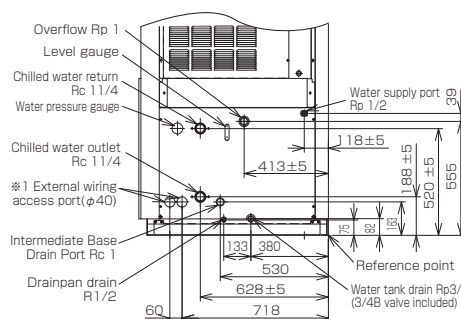

**RKE18000A-VW**

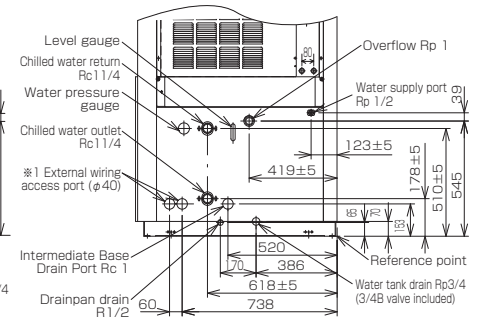

※ 1 : Signal and communications related wiring should not pass through the same hole as power cables.

**Pump Characteristic Curves**

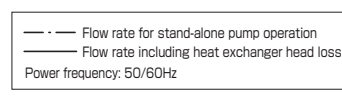
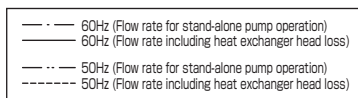

**RKE15000A-VW**

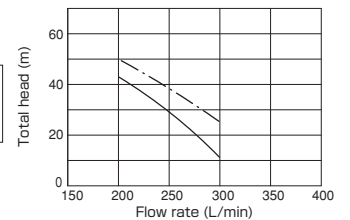

1. Internal (return side) head loss: 0.7m or less.

**RKE3750A-VW**

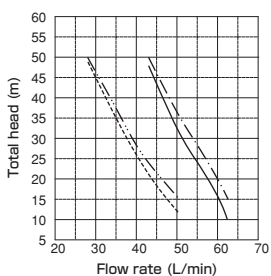

1. Internal (return side) head loss: 0.2m or less.

**RKE5500A-VW / 7500A-VW**

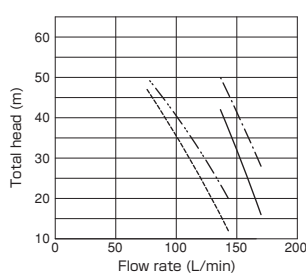

1. Internal (return side) head loss: 0.7m or less.

**RKE11000A-VW**

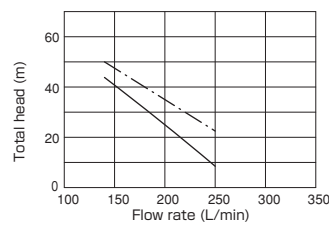

1. Internal (return side) head loss: 0.7m or less.

**RKE18000A-VW**

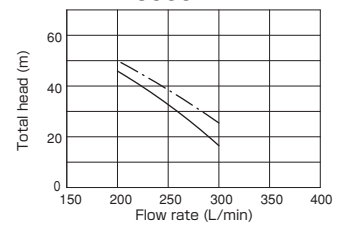

1. Internal (return side) head loss: 0.7m or less.

**Built-in Water Tank**

# Super Heavy Duty Energy Saving Chiller

**ORION**  
Patented

Super Heavy Duty Inverter Chiller Series

Built To Order

Cooling capacity: 66.0/69.0 k - /96.0 kW

Refrigeration Equipment

## Model Outline

Digitally Controlled Compressor	Built-In Discharge Pump	Digital Temperature Control	External Warning Alarm Terminals Operation / Alarm / Remote operation	Condenser Filter Included (Air cooled model)	Rated for 3 Power Sources	Freeze Prevention Mode (User selectable)	IPX4 Equip. Rating Splash-proof	Multi-Function Parameters
					HFC Refrigerant R407C	Warm-Up Mode	External Communications Capability (RKE22000A-V, RKE22000A-VW models only)	50/60Hz Same Power Output (RKE30000A-V, RKE30000A-VW models only)

## Features

- Operates with a maximum energy savings of 57%. \***  
Orion chillers respond to work loads using the least amount of energy.  
(\* Compared with HB control models running at a 30% load)
- Highly accurate fluid temperature control possible. Patented**  
The chiller senses the fluid temperature and adjusts the compressor speed accordingly, thus achieving fluid temperature precision control of  $\pm 0.2 \sim \pm 1.0^\circ\text{C}$ . (Accuracy is subject to work loads. Please consult your dealer if high accuracy is demanded.)
- Wide range of fluid temperature control.**  
The adjustable fluid temperature control range is  $15 \sim 30^\circ\text{C}$ .
- Adopted for use with environmentally friendly refrigerant.**  
Uses non ozone-depleting R407C refrigerant.
- Adopted for use with environmentally friendly refrigerant.**  
Uses non ozone-depleting R407C refrigerant.  
RKE30000A-V, RKE30000A-VW models excluded.  
Allows temperature control via RS232C or RS422 interfaces.



RKE22000A-V

## Specifications

Item	Model	Air cooled		Water cooled						
		RKE22000A-V	RKE30000A-V	RKE22000A-VW	RKE30000A-VW					
Performance specifications	Cooling capacity * 1	kW		66.0/69.0	96.0	70.0/73.0	96.0			
	Operable ambient temperature range	$^\circ\text{C}$		$-5 \sim 43$		$2 \sim 43$				
	Operable fluid temperature range	$^\circ\text{C}$		$15 \sim 30$						
Power specifications	Control accuracy * 4	Under high accuracy setting $\pm 1.0^\circ\text{C}$ ( $\pm 0.5^\circ\text{C}$ during stable load), under energy-saving setting $\pm 1.0^\circ\text{C}$ ( $\pm 0.5^\circ\text{C}$ during stable load, $\pm 2.0^\circ\text{C}$ during ON/OFF cycle mode)								
	Power source * 2	V(Hz)								
	Power consumption * 1	kW		43.0/45.8, 45.8		50, 50		38.0/40.0, 40.0	43, 43	
	Electric current * 1	A		133/136, 136		160, 160		125/128, 128		126, 126
	Power capacity * 3	kVA		50.0		60		50.0		54
Equipment details	Breaker capacity	A		*6 175		*6 175		175		
	Condenser	Fin and tube forced air cooling				Double pipe water cooling				
	Heat exchanger	Construction	Plate type heat exchanger							
		Material	SUS316 grade stainless steel (brazing: copper)							
	Discharge pump	Output	3.2 Inverter driven pump $\times 2$							
		Flow rate	L/min						Minimum 400 (Head: 50m)	
	Fan motor output	kW		2.2(inverter driven)   0.75(inverter driven)		2.2(inverter driven pump) $\times 2$ pumps		—		
Water tank capacity	L		approx. 250		approx. 320		approx. 250		approx. 320	
Refrigerant	R-407C									
Outside dimensions (HxDxW)	mm		2190 $\times$ 1200 $\times$ 2010		2190 $\times$ 1340 $\times$ 2350		1700 $\times$ 1240 $\times$ 2050		1700 $\times$ 1340 $\times$ 2350	
Unit mass (dry weight)	kg		approx. 1050		approx. 1420		1100		1420	
Operating noise level (50/60Hz) * 5	dB		71		72		61		62	

\* 1 During operation when the cooling water temperature is  $20^\circ\text{C}$  and the ambient temperature is  $32^\circ\text{C}$ . Cooling capacity will be at least 95% of the noted figures. \* 2 Source voltage phase unbalance should be less than  $\pm 3\%$ . \* 3 The figure noted is when the equipment is operating at the highest capacity of its normal operating range. \* 4 Stable load indicates continued operation with maximum load fluctuations of  $\pm 10\%$  of the current load. (However, this excludes cases where the electronic capacity control valve cycles on and off.) The setting can be changed by adjusting parameter F15. (Default value: High-accuracy setting.) \* 5 Operating noise levels are from a position of 1m in front of the unit and at a height of 1m. \* 6 Unit comes with a built-in multi-purpose overload and short circuit protection breaker. Note 1: Please install the included strainer (40 mesh) to the fluid intake port. Note 2: The chilled fluid can be either potable water or a low concentration ethylene glycol water solution of 10% or less. Note 3: Heat output of the equipment (in kW) is about 1.3 times the cooling capacity. (air cooled models only)

## Cooling Capacity

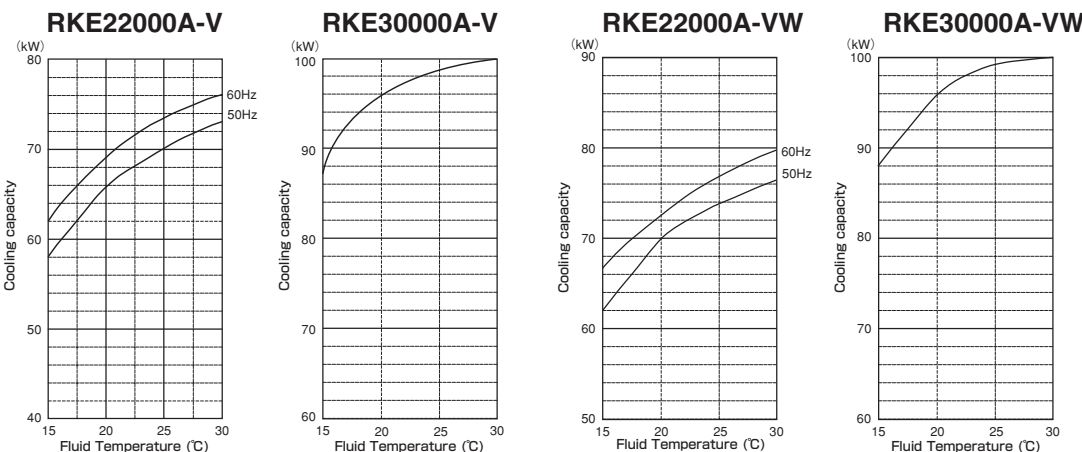

Conditions  
· Ambient temperature:  $32^\circ\text{C}$   
· Fluid: Tap water

Conditions  
· Ambient temperature:  $32^\circ\text{C}$   
· Fluid: Tap water

Conditions  
· Cooling water temperature:  $32^\circ\text{C}$   
· Fluid: Tap water

Conditions  
· Cooling water temperature:  $32^\circ\text{C}$   
· Fluid: Tap water

## Cooling Water Flow Rate (for condenser)

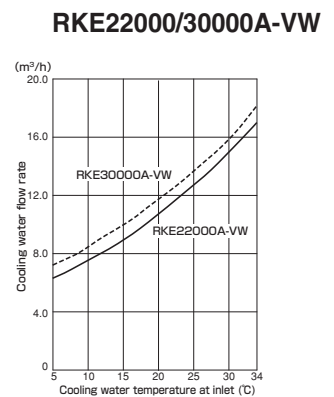

Condition  
· Chilled water temperature:  $30^\circ\text{C}$

**External dimensions**

**RKE22000A-V**

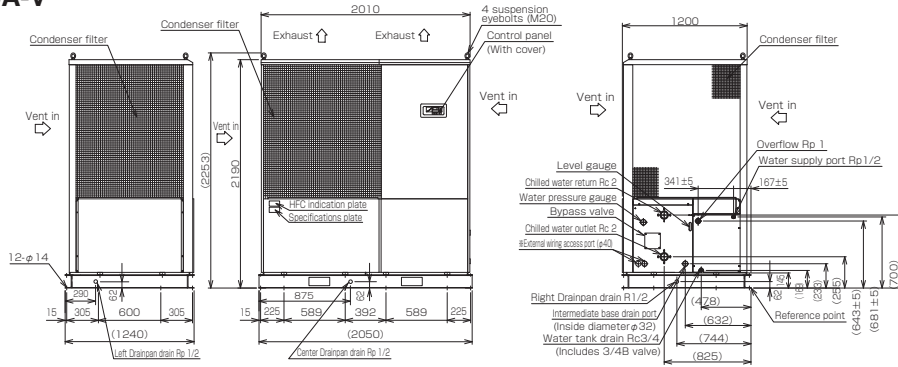

(Units: mm)

**RKE22000A-VW**

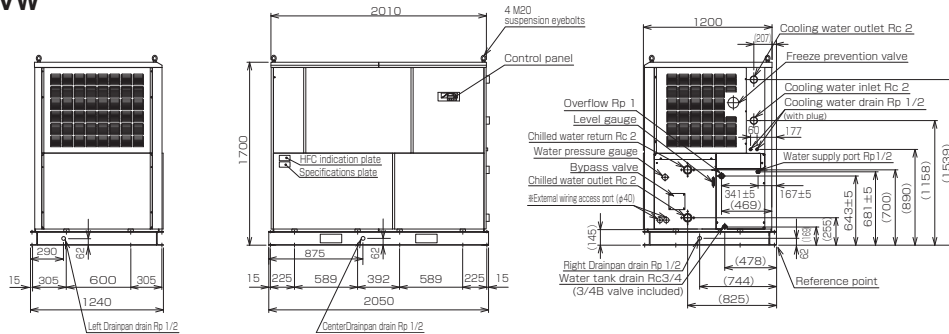

(Units: mm)

**RKE30000A-V**

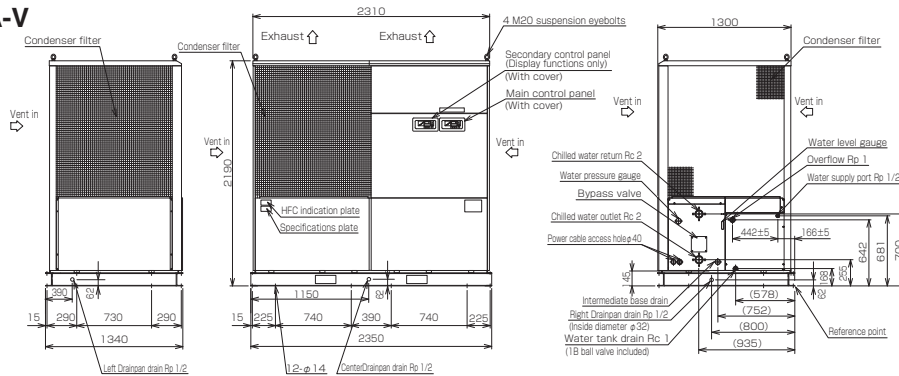

(Units: mm)

**RKE30000A-VW**

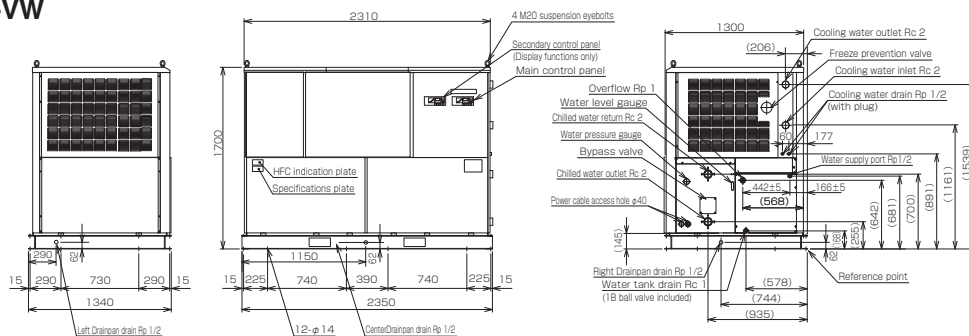

(Units: mm)

**Pump Characteristic Curves**

**RKE22000A-V, A-VW  
RKE30000A-V, A-VW**

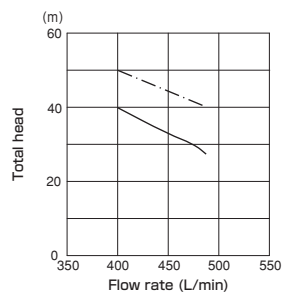

--- : Flow rate for stand-alone pump operation  
— : Flow rate including heat exchanger head loss

Power frequency: 50/60Hz  
1. Installed pumps: Two 40MMF03.2 pumps  
2. Internal (return side) head loss: 0.7m or less.

# Fluid Temperature Control Equipment

**ORION**

Patent pending

With Free Cooling Function **Eco Hybrid** Built To Order

Cooling capacity: 28/33kW Refrigeration Equipment

## Model Outline

Digitally Controlled Compressor	Built-In Discharge Pump	Digital Temperature Control	External Warning Alarm Terminals Operation / Alarm / Remote operation	Condenser Filter Included	Outside Installation OK
Multi-Function Parameters	High Efficiency Refrigerant R410A	Warm-Up Mode	External Communication Capability		



FCC10A

## Features

- Annual Power Consumption Reduced By As Much As 65%.**  
As much as 65% reduction in energy possible by the use of natural (outside air) energy and fan cooler.
- Plus improved ambient temperature conditions.**  
Ambient temperature range increased to -10°C to 45°C. Works well in harsh, summer environments.(When using water spray.)
- Units can be tied together for modular chiller operation.**  
Supports water tank pressure equalization for multi-unit operation. (Pressure equalization must be carried out on-site. Please ask your dealer for details.)

## Specifications

Model		FCC10A		
Performance specifications	Cooling capacity ※ 1	kW	28/33	
	Ambient temp. range	°C	-10~45	
	Set fluid temperature range	°C	18~35	
	Control accuracy	± 1.0°C (during stable load conditions)		
Power specifications	Power source	V(Hz)	3φ200±10%(50Hz/60Hz), 220±10%(60Hz)	
	Power consumption ※ 1	kW	14/17, 17	
	Electric current ※ 1	A	45/52, 52	
	Power supply capacity	kVA	20	
Equipment details	Condenser / External heat exchanger		Fin and tube forced air cooling	
	Evaporator construction / materials		Plate type heat exchanger / SUS316 (brazing:copper)	
	Discharge pump	Output	kW	1.26/2.1 (50Hz/60Hz)
		Flow rate	L/min	70/125(50Hz/60Hz) [Head: 50m]
	Circulation pump output		kW	0.75
	Fan motor output		kW	0.7 (DC inverter driven)
	Refrigerant		R-410A	
Water tank capacity	L	Approx. 60		
External dimensions (HxDxW)	mm	2300 × 960 × 1200		
Water spray rate	L/min	4 (max.)		
Spray device supply water pressure ※ 2	MPa	0.2~0.5		
Unit mass (dry weight)	kg	467		
Operating noise level ※3	dB	Max. 65		

※ 1 When ambient temperature is 32°C and fluid temperature is 20°C .  
 ※ 2 Raise the water supply pressure if it is below 0.2 MPa.  
 ※ 3 Operating noise levels are from a position of 1m in front of the unit and at a height of 1m.  
 Optional equipment: Snow protection hood, Ventilation hood

## External dimensions

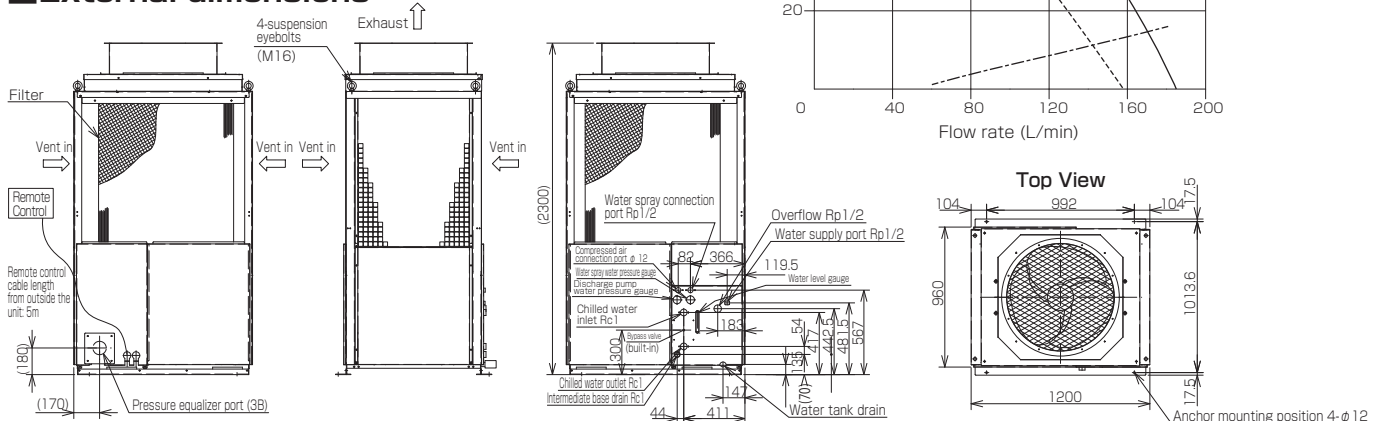

## Cooling Capacity

Graph of Cooling Capacity with Cooling Unit

※ Please confirm the cooling capacity of the compressor graph when making a model choice.

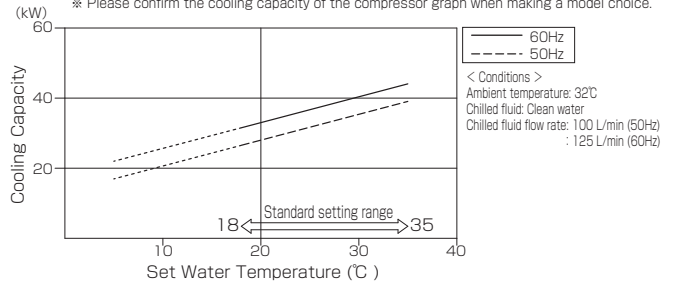

Cooling capacity as much as at 50Hz.

(kW) (Compressor and fan cooler at maximum operating level, ambient temperature of 5°C or higher, with water spray)

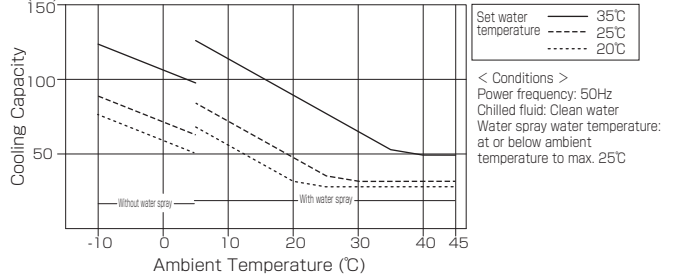

## Pump Characteristic Curves

Ratings for stand-alone pump operation.

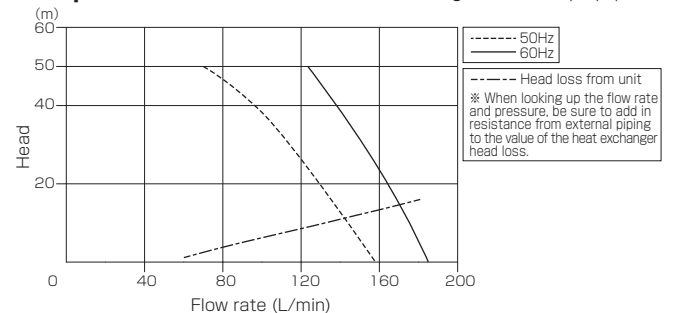

# Built-in Water Tank

# Light Duty Chiller Unit Cooler RKS Series

# ORION

Cooling capacity: 0.89/1.02kW Refrigeration Equipment

## Model Outline

Built-In Discharge and Circulation Pump	Digital Temperature Control	External Warning Alarm Terminals (Operation / Alarm / Remote operation)	Condenser Filter Included	Multi-Directional Vent	Freeze Prevention Mode (User selectable)
		*Only when the vent direction panel is installed on top of the unit.	IPX3 Equiv. Rating Splash-proof	HFC Refrigerant R407C RKS400F-VS	High Efficiency Refrigerant R410A RKS400F1-V



RKS400F-VS

## Features

- Water tank and pump built into a single package**  
No bothersome on-site installation of water tank or pump required. Perfect for where layout space is at a premium.
- Upper level water tank facilitates cleaning.**  
Even with built-in water tanks, regular maintenance must be performed to keep bad water, algae, etc. at bay in order to maintain water quality. The RKS series has the water tank on top so that by just opening a cover, the tank can be accessed for easy cleaning.

## Specifications

Item	Model	Air cooled		
		RKS400F-VS	RKS400F1-V	
Performance specifications	Cooling capacity (50/60Hz) ※ 1,2	kW 0.89/1.02		
	Operable ambient temperature range	°C 5~43		
	Operable temperature range (fluid temperature)	°C 5~30		
Power specifications	Power source	V (Hz) Single phase 100 ± 10% (50/60) Three phase 200 ± 10% (50/60)		
	Power consumption (50/60Hz 220V) ※ 2	kW 0.52/0.67		
	Electric current (50/60Hz) ※ 2	A 6.2/6.6		
	Power capacity	kVA 0.8		
	Breaker capacity	A 15		
Equipment details	Condenser	Fin and tube forced air cooling		
	Heat exchanger	Construction	Shell and coil	
		Material	Shell: ABS, Coil: SUS304 grade stainless steel	
	Circulation pump output (50/60Hz)	W	20	
		※ 3 Output	W 150	
	Discharge pump	Flow rate (50/60Hz)	L/min 19/26 (Head:10m)	
		Water tank capacity	L Approx. 35	
	Fan motor output ※ 4	W 10		
	Refrigerant		R-407C	R-410A
	Outside dimensions (H×D×W)	mm 900×550×470		
Unit mass (dry weight)	kg Approx. 70			
Operating noise level (50/60Hz) ※ 5	dB 59/61			

※ 1 Cooling capacity is at least 95% of listed figures. ※ 2 When fluid temperature is 20°C and ambient temperature is 32°C. ※ 3 The capacity figures listed represent just one point on this model's flow-rate/head characteristic curve. Pumps differ between models; for model specific details, please refer to the pump characteristic curves. ※ 4 Fan motor static pressure is 20Pa. ※ 5 Operating noise levels are from a position of 1m in front of the unit and at a height of 1m.  
Note 1: The chilled fluid can be either potable water or a low concentration ethylene glycol water solution of 10% or less.  
Note 2: Heat output of the equipment (in kW) is about 1.3 times the cooling capacity. (air cooled models only)

## External dimensions

### RKS400F-VS / 400F1-V

(Units: mm)

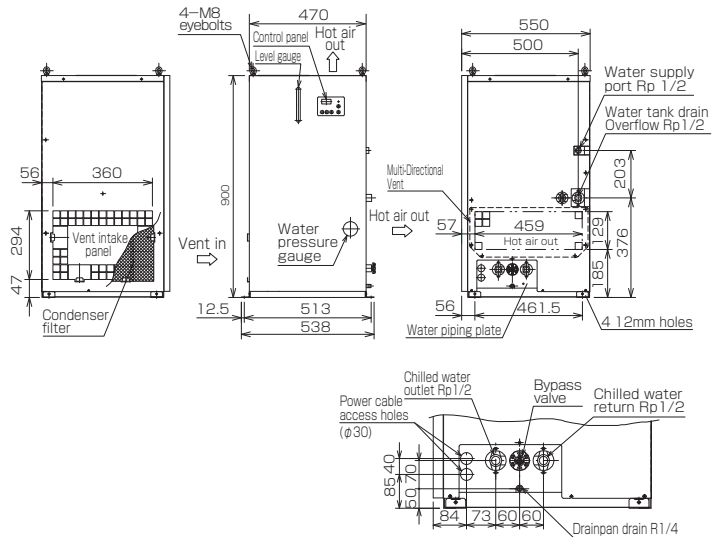

Water plumbing plate is detailed

## Cooling Capacity

### RKS400F-VS/400F1-V

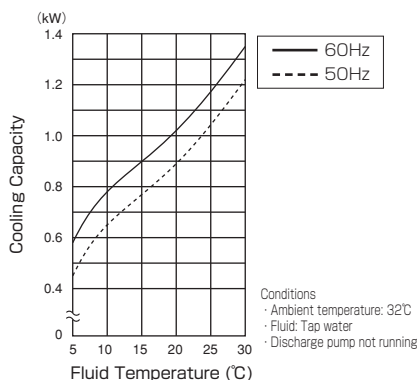

## Pump Characteristic Curves

Ratings for stand-alone pump operation.

### RKS400F-VS / 400F1-V

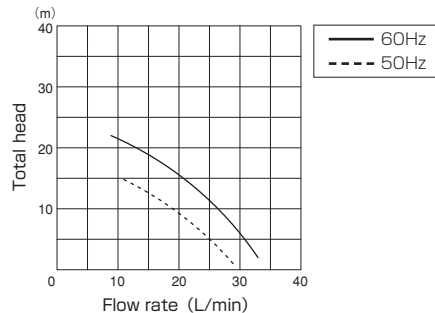

※ Use at pressures of 0.15/0.22MPa and below

## Pump Heat Dissipation Capacity Curves

Ratings for stand-alone pump operation.

### RKS400F-VS / 400F1-V

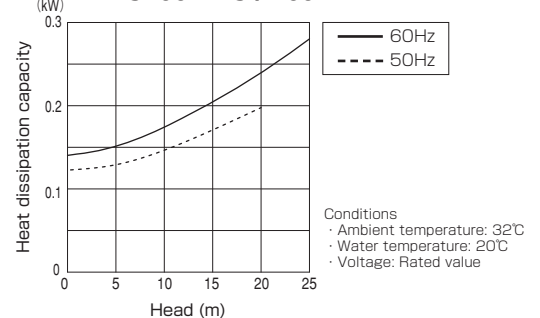

**Without Water Tank**

# Light Duty Chiller

**ORION**

## Unit Cooler RKS Series

Cooling capacity: 0.59/0.62 kW - 4.30/4.65 kW Refrigeration Equipment

### Model Outline

<b>Built-In Circulation Pump</b>	<b>Digital Temperature Control</b>	<b>External Warning Alarm Terminals Operation / Alarm / Remote operation</b>	<b>Condenser Filter Included</b> except RKS750F-W	<b>Rated for 3 Power Sources</b> RKS1500F	<b>Multi-Directional Vent</b> RKS1500F	<b>HFC Refrigerant R407C</b> except RKS400F1	<b>High Efficiency Refrigerant R410A</b> RKS400F1
----------------------------------	------------------------------------	--	--	--	---	---	--

### Features

- Built with a heat exchanging coil that inhibits clogging and can be disassembled when required.**

Chillers that use external water tanks are susceptible to foreign substances entering the system.

With Orion's distinctive heat exchange coil system, there is less likelihood of clogging and yet, in the unlikely chance that clogging does occur, the coil can be removed for cleaning.

- Connections and controls are focused onto the front panel for improved ease of use.**

Installation layout has been greatly improved with the control switch, temperature display, water IN and OUT piping, and drain port, all concentrated onto the front panel.

- Works well in space saving, low profile environments.**

The height of the chiller has been lowered as much as possible allowing convenient placement in most site layouts.



RKS250F-S  
RKS400F-S  
RKS400F1  
RKS500F  
RKS750F (shown here)



RKS1500F

### Specifications

Item	Model	Air cooled					Water cooled										
		RKS250F-S	RKS400F-S	RKS400F1	RKS500F	RKS750F	RKS1500F	RKS750F-W									
Performance specifications	Cooling capacity (50/60Hz) ※1.2	kW		0.59/0.62		0.89/1.02		1.3/1.4		2.00/2.20		4.30/4.65		1.98/2.21			
	Operable ambient temperature range	°C		5~40		5~40		5~40		5~40		5~40		5~40			
	Operable temperature range (fluid temperature)	°C		5~25		5~25		5~25		5~25		5~25		5~25			
Power specifications	Power source	V (Hz)		Single phase 100 ± 10% (50/60)		Three phase 200 ± 10% (50/60)				Three phase 200 ± 10% (50/60) 220 ± 10% (60)		Three phase 200 ± 10% (50/60)					
	Power consumption (50/60Hz) ※2	kW		0.36/0.38		0.42/0.49		0.45/0.50		0.72/0.85		0.85/1.05		1.6/2.1, 2.1 ※5		0.73/0.89	
	Electric current (50/60Hz) ※2	A		4.6/4.0		4.8/5.1		1.85/1.75		3.0/2.8		3.2/3.6		6.0/7.0, 6.9 ※5		2.7/3.0	
	Power capacity	kVA		0.6		0.7		0.8		1.3		1.6		3.5		1.2	
	Breaker capacity	A		10		10		5		5		10		15		5	
Equipment details	Condenser	Fin and tube forced air cooling											Double pipe water cooling				
	Heat exchanger	Construction	Shell and coil														
		Materials	Shell: ABS. Coil: SUS304 grade stainless steel														
	Circulation pump (50/60Hz)	Output	W		20				45		85/150		45				
		Circulation rate	L/min		15~24/15~27				20~27/20~30		30~50/30~60		20~27/20~30				
	Fan motor output ※3	W		10				25		100		—					
Refrigerant	R-407C				R-410A				R-407C								
Outside dimensions (HxDxW)	mm		283×375×454		295×375×454		333×375×484		398×405×534		600×500×650		398×405×534				
Unit mass (dry weight)	kg		Approx. 25		Approx. 30		Approx. 35		Approx. 43		Approx. 70		Approx. 45				
Operating noise level (50/60Hz) ※4	dB		53/57				55/59		57/59		51/55						
Required water tank capacity	L		10 or larger		20 or larger		25 or larger		35 or larger		60 or larger		35 or larger				

※ 1 Cooling capacity is at least 95% of listed figures. ※ 2 When fluid temperature is 20°C and ambient temperature is 32°C. ※ 3 Fan motor static pressure is 20Pa.

※ 4 Operating noise levels are from a position of 1m in front of the unit and at a height of 1m. ※ 5 At 200V 50/60Hz or 220V 60Hz

Note 1: The chilled fluid can be either potable water or a low concentration ethylene glycol water solution of 10% or less.

Note 2: Heat output of the equipment (in kW) is about 1.3 times the cooling capacity. (air cooled models only) Note 3: RKS750F-W is a built to order item.

### Cooling Capacity

**RKS250F-S  
400F-S / 400F1 / 500F**

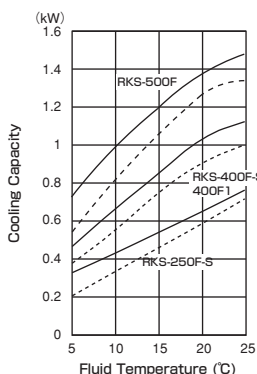

Conditions  
- Room temperature: 32°C  
- Fluid: Tap water

**RKS750F**

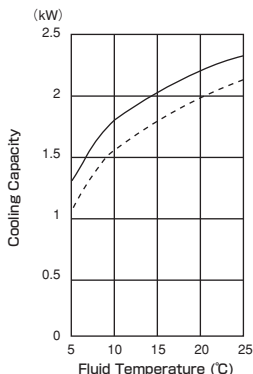

Conditions  
- Room temperature: 32°C  
- Fluid: Tap water

**RKS1500F**

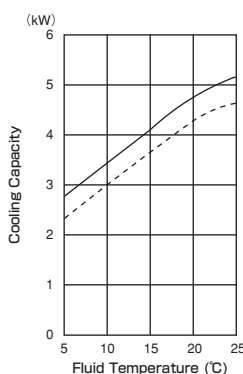

Conditions  
- Room temperature: 32°C  
- Fluid: Tap water

**RKS750F-W**

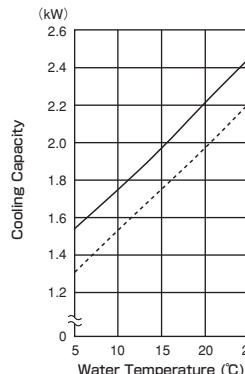

Conditions  
- Cooling water temperature: 32°C  
- Fluid: Tap water

**RKS750F-W**

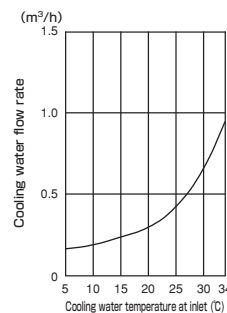

Conditions  
- Fluid temperature: 20°C  
- Cooling water circuit head loss: 10m  
- Cooling tower capacity: at least 4.5kW

### Cooling Water Flow Rate (for condenser)



**External dimensions**

Model \ Dimension	W	H	A	B	C	D	E	F	G	J	K
RKS250F-S	454	313	275	28.5	28.5	155	45	60	28	37.2	320
RKS400F-S, 400F1	454	325	287	28.5	28.5	155	45	72.5	27.5	43	320
RKS500F	484	363	325	41.7	45.3	138.5	61.5	74	64	39.5	350

(Units: mm)

**RKS250F-S  
400F-S  
400F1  
500F**

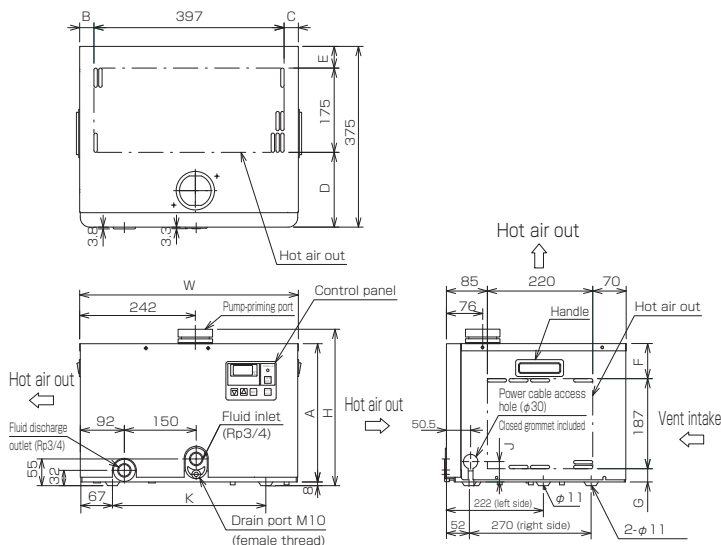

**RKS750F**

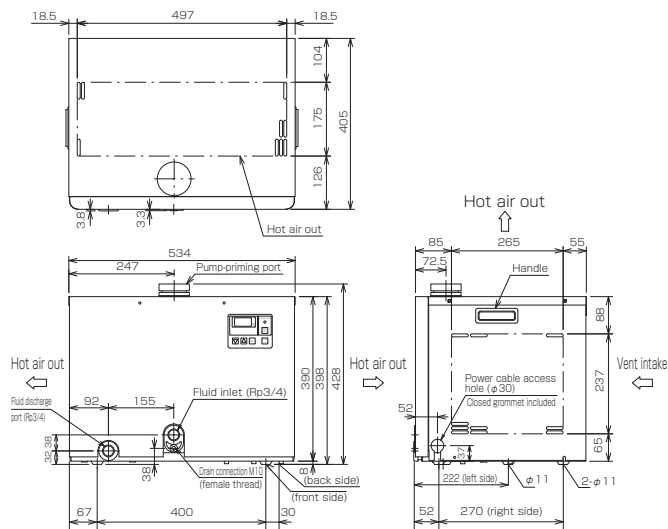

※ Models RKS-250F-S and 400F-S come with a power cord and plug. (length outside chiller: 2m)

**RKS750F-W**

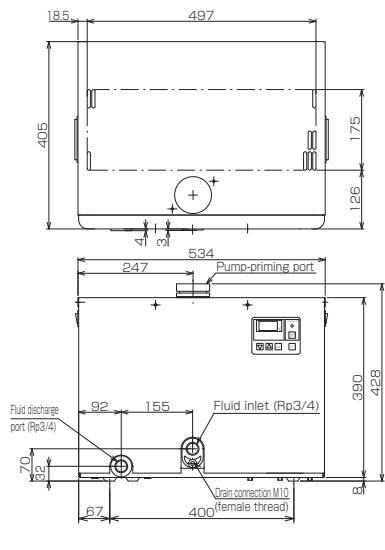

**RKS1500F**

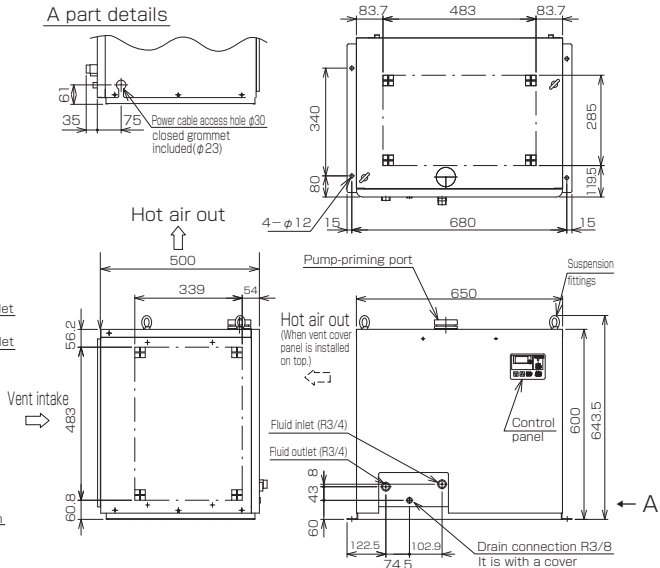

**Pump Characteristic Curves**

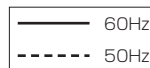

**RKS250F-S / 400F-S / 400F1 / 500F**

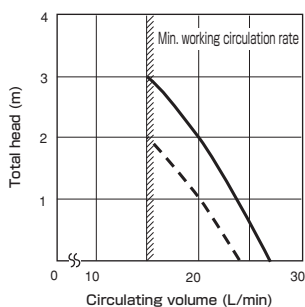

**RKS750F / 750F-W**

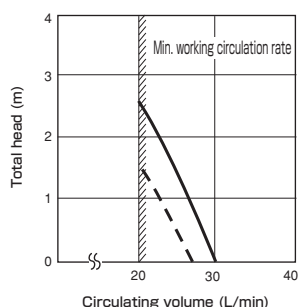

**RKS1500F**

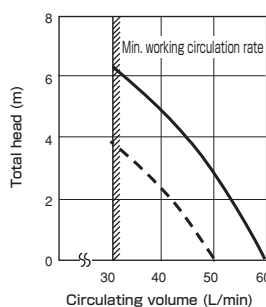

**Without  
Water Tank**

# Heavy Duty, Air Cooled Chiller

**ORION**

## Unit Cooler RKL Series

Cooling capacity: 7.9/8.5 kW - 25.0/27.1 kW Refrigeration Equipment

### Model Outline

- Built-In Circulation Pump
- Digital Temperature Control
- External Warning Alarm Terminals  
Operation / Alarm / Remote operation
- Condenser Filter Included
- IPX3 Equiv. Rating Splash-proof
- Rated for 3 Power Sources
- HFC Refrigerant R407C



RKL-2200-D RKL-3750-D (shown here)  
RKL-5500-D RKL-7500-D

### Features

- Built with a heat exchanging coil that inhibits clogging and can be disassembled when required.**

Chillers that use external water tanks are susceptible to foreign substances entering the system.

With Orion's distinctive heat exchange coil system, there is less likelihood of clogging and yet, in the unlikely chance that clogging does occur, the coil can be removed for cleaning.

- Space saving design is perfect for space conscious layouts.**

Slim vertical design. The unit can be placed with the back side against the wall.

### Specifications

Item		Model	Air cooled			
			RKL-2200-D	RKL-3750-D	RKL-5500-D	RKL-7500-D
Performance specifications	Cooling capacity (50/60Hz) ※ 1,2	kW	7.9/8.5	11.6/12.2	18.7/20.3	25.0/27.1
	Operable ambient temperature range	°C	5~43			
	Operable temperature range (fluid temperature)	°C	5~30			
Power specifications	Power source	V (Hz)	Three phase 200 ± 10% (50/60), 220 ± 10% (60)			
	Power consumption (50/60Hz, 220V) ※ 2	kW	3/4, 4	5/6, 6	7/8, 8	10/12, 12
	Electric current (50/60Hz, 220V) ※ 2	A	11/13, 13	18/20, 20	24/27, 27	33/37, 37
	Power capacity ※ 3	kVA	5.5	8.3	11.8	18.7
	Breaker capacity	A	20	30	40	60
Equipment details	Condenser		Fin and tube forced air cooling			
	Heat exchanger	Construction	Shell and coil			
		Material	Shell: polyethylene, Coil: SUS304 grade stainless steel			
	Circulation pump (50/60Hz)	Output	W	150/180	400	750
		Circulation rate	L/min	40~60/40~70	70~115/70~130	80~120/80~140
	Fan motor output ※ 4	W	100 (inverter driven)	200 (inverter driven)	750 (inverter driven)	
Refrigerant			R-407C			
Outside dimensions (HxD×W)	mm	1400×677×860	1445×705×1025	1740×815×1287		
Unit mass	kg	Approx. 200	Approx. 270	Approx. 600	Approx. 650	
Operating noise level (50/60Hz) ※ 5	dB	59/61	61/64	64/67	65/68	
Required water tank capacity	L	At least 200	At least 300	At least 450	At least 600	

※ 1 Cooling capacity is at least 95% of listed figures. ※ 2 When fluid temperature is 20°C and ambient temperature is 32°C. ※ 3 The figure noted is when the equipment is operating at the highest capacity of its normal operating range. ※ 4 Fan motor static pressure is 20Pa. ※ 5 Operating noise levels are from a position of 1m in front of the unit and at a height of 1m. Note 1: The chilled fluid can be either potable water or a low concentration ethylene glycol water solution of 10% or less. Note 2: Heat output of the equipment (in kW) is about 1.3 times the cooling capacity. (air cooled models only)

### Cooling Capacity

— 60Hz  
- - - 50Hz

RKL-2200-D/3750-D

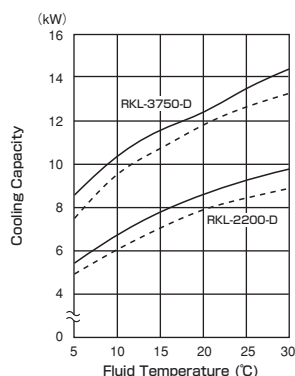

Conditions  
· Room temperature: 32°C  
· Fluid: Tap water

RKL-5500-D / 7500-D

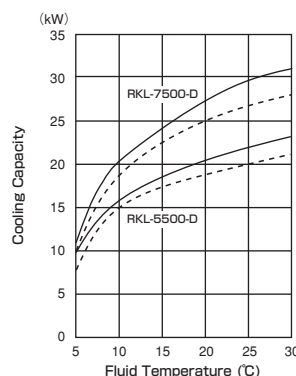

Conditions  
· Room temperature: 32°C  
· Fluid: Tap water

**External dimensions**

(Units: mm)

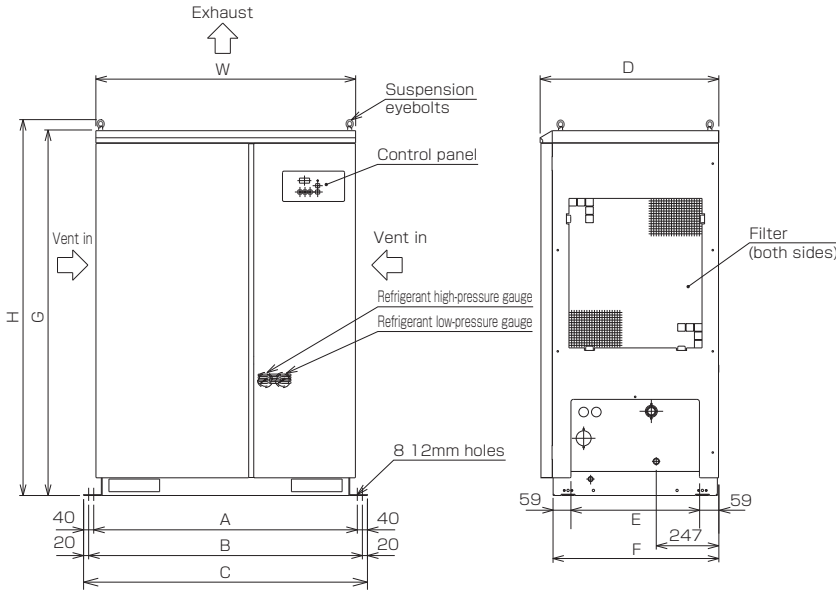

Model	Dimension	W	D	H	A※2	B※1	C	E	F	G
RKL-2200-D		860	677	1441	876.7	916.7	956.7	502.7	620.7	1400
RKL-3750-D		1025	705	1486	1040	1080	1120	530	648	1445
RKL-5500-D, 7500-D		1287	815	1800	1305	1345	1385	637	755	1740

※1 For anchor fixation  
 ※2 RKL-5500-B1 and 7500-B1 hole pitch sizes are compatible with this chiller. When upgrading from RKL-5500-B1 and 7500-B1, please use the pitch sizes listed here.

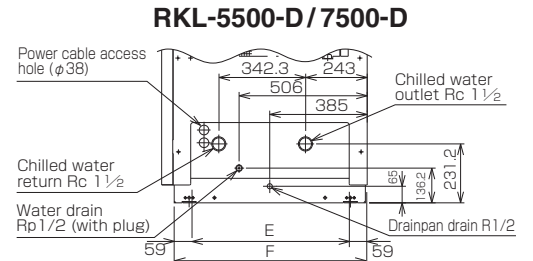
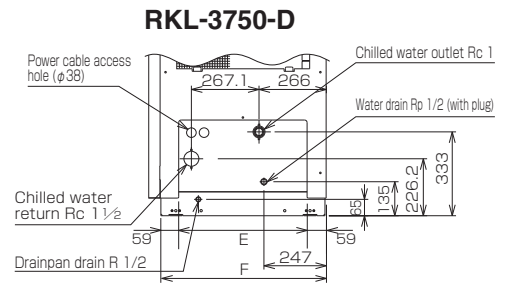
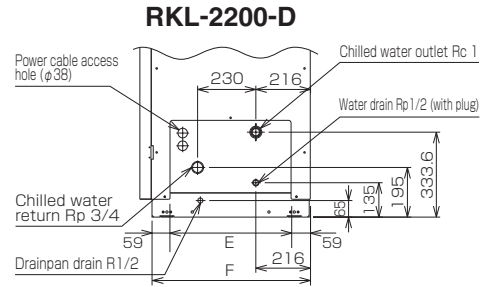

Water piping plate detail

**Pump Characteristic Curves**

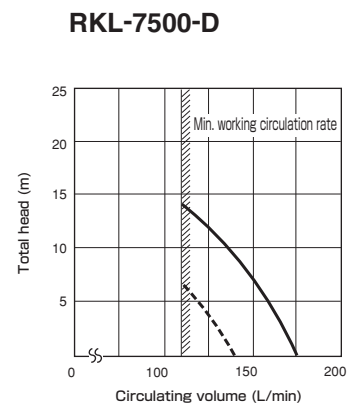
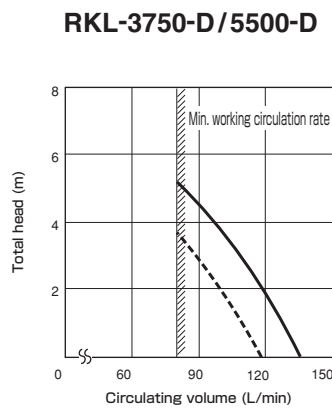
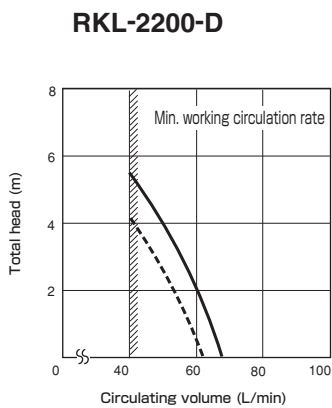
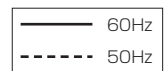

# Working Principles and Model Configurations

## (Chiller and Unit Cooler Series)

### Working principles -- Diagrams

#### Without Built-In Water Tank (Open loop)

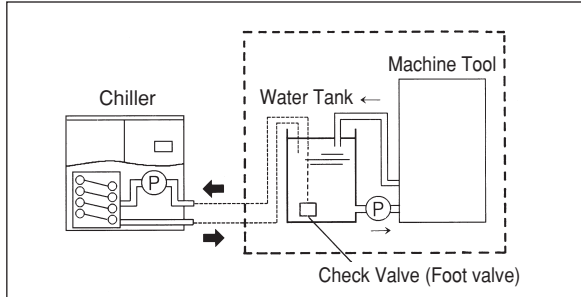

#### With Built-In Water Tank (Closed loop)

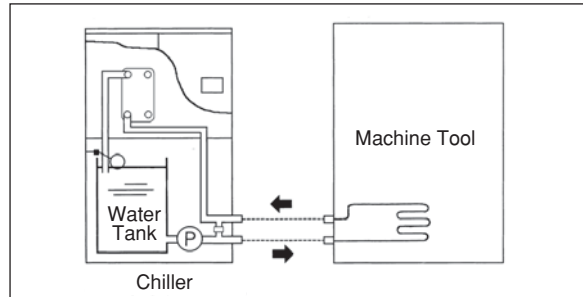

#### Working Principles

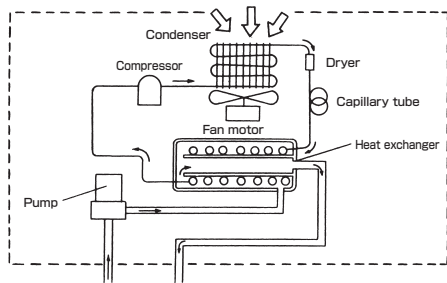

The circulation pump pumps in fluid from the water tank and then through the heat exchanger. There, the fluid is cooled and then returns to the tank. This cycle is repeated and the fluid is continuously cooled until it reaches the desired set temperature, at which time the temperature regulator shuts off the chiller. And if the fluid temperature rises above the set control value, the chiller is automatically started again. Thus, the temperature is maintained, and maintenance costs remain low.

\* For models without built-in water tanks, a separate water tank must be installed. In such cases, the water tank must have a capacity suitable for the model of chiller it is to be used with. Please refer to individual model specifications for further details.

#### Working Principles

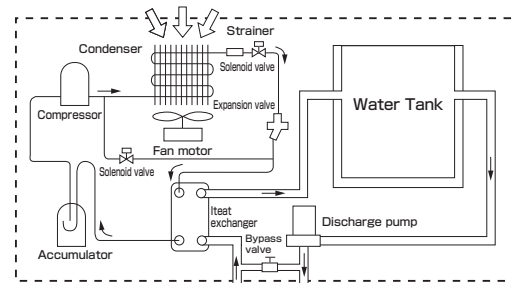

The pump built into the unit pumps fluid from the water tank and then through the heat exchanger. There, the fluid is cooled and then returns to the tank. This cycle is repeated and the fluid is continuously cooled until it reaches the desired set temperature, at which time the temperature regulator shuts off the chiller. And if the fluid temperature rises above the set control value, the chiller is automatically started again. In this way, the fluid temperature is maintained and the fluid is pumped out via the discharge pump.

\* In addition to the discharge pump, some models are equipped with built-in circulation pumps. Please refer to individual model specifications for further details.

## Making the right model choice

### 1. Sample cooler heat calculation and model selection methods are listed below.

Please make a model choice that best suits your operating conditions and requirements.

**Example 1** Find the cooling capacity required to deal with heat generated by a piece of equipment which is to be cooled by a chilled water flow; the temperature difference between the cooling water going into and out of the equipment is known.

The equipment to be cooled is accepting a cooling water flow of 12 L/min, the water temperature going into the equipment is 17°C, and the temperature of the water coming out is 20°C. What is the amount of heat being generated by this equipment?

$$Q = \frac{(t_2 - t_1) \times (X \times 60) \times C}{860} = \frac{(20 - 17) \times (12 \times 60) \times 1}{860} = 2.51 \text{ kW}$$

Factoring in a 30% loss due to external piping:  $2.51 \times 1.3 = 3.26 \text{ kW}$

- Q: Amount of heat in kW (1kW = 860kcal/h)
- W: Weight of cooling liquid (volume x specific gravity)
- C: Relative heat in kcal/kg°C (in case of water: 1)
- t<sub>2</sub>: Upper temperature (°C)
- t<sub>1</sub>: Lower temperature (°C)
- H: Required cooling time in hours
- P: Power from an electric heater running 1 hour in kW
- X: Water flow per minute: L/min

**Example 2** In case a certain temperature drop is required in a fixed amount of time.

For example, if 40L of 20°C water is in a separate tank, what is the heat dissipation required to lower the temperature of the water to 5°C in one hour?

$$Q = \frac{W \times C \times (t_2 - t_1)}{H \times 860} = \frac{40 \times 1 \times (20 - 5)}{1 \times 860} = 0.7 \text{ kW}$$

\* For coolers that have a built in water tank, use the capacity of the water tank in place of the volume of water.

Note: When making a model selection, also consider heat from external sources that might raise the temperature of the water in the water tank. In order to compensate for such external heat sources, it is recommended that an additional 20% in cooling capacity be added to the power calculation.

$$Q = 0.7 \times 1.2 = 0.84 \text{ kW}$$

**Example 3** An electric heater with a heat load of 5kW is to be cooled. The temperature at the cooling water inlet is 17°C and the temperature at the cooling water outlet is 25°C. In this case, what is the circulation flow rate required?

$$X = \frac{P \times 860}{(t_2 - t_1) \times 60} = \frac{5 \times 860}{(25 - 17) \times 60} = 9.0 \text{ L/min}$$

## 2. Piping Resistance Calculations

Piping methods and other particulars have a large effect on the flow rate, head, and resistance of the water cycle. Furthermore, safety devices may also be operating, so it is important to install a piping design that can keep within the prescribed piping resistance (head) limitations.

The following describes how to calculate the head of a system.

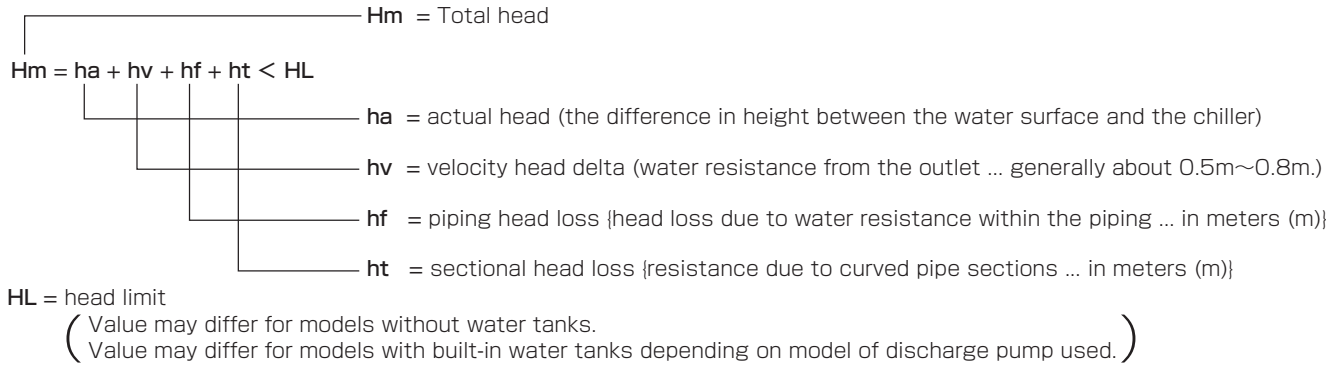

■ The choice of chiller (pump) should be based on the pump characteristic curves as well as the head and circulation load, and allow for sufficient leeway.

### Example 1: How to find $H_f$

What is the head loss in a piping system where the inside diameter of the piping is 20mm, the equivalent length is 20m, and the water flow is 50 L/min?

- 50 L/min = 0.05 m<sup>3</sup>/min. According to the chart below, the head loss at this value is 40m per 100 meters of piping, which comes to a head loss of 0.40m per meter of piping. So the actual head loss for 20m of such piping is  $0.4 \times 20 = 8.0\text{m}$ .

### Example 2: How to find $H_t$

What is the head loss for a 20mm I.D. elbow section with a water flow of 50 L/min?

- First, find the equivalent length of the elbow pipe. Make a straight line from the point of the standard elbow on the ① line below to the 20mm point on the ③ line. The point where this line intersects line ② indicates the equivalent length of the elbow section. According to the chart below, the equivalent length of the pipe is 0.6m.
- In Example 1 it was determined that a 1m section at 50 L/min yields a head loss of 0.40m. So it follows that the head loss for the elbow section with would be:  $0.6 \times 0.40 = 0.24\text{m}$ .

Head Loss within Hard PVC Pipe

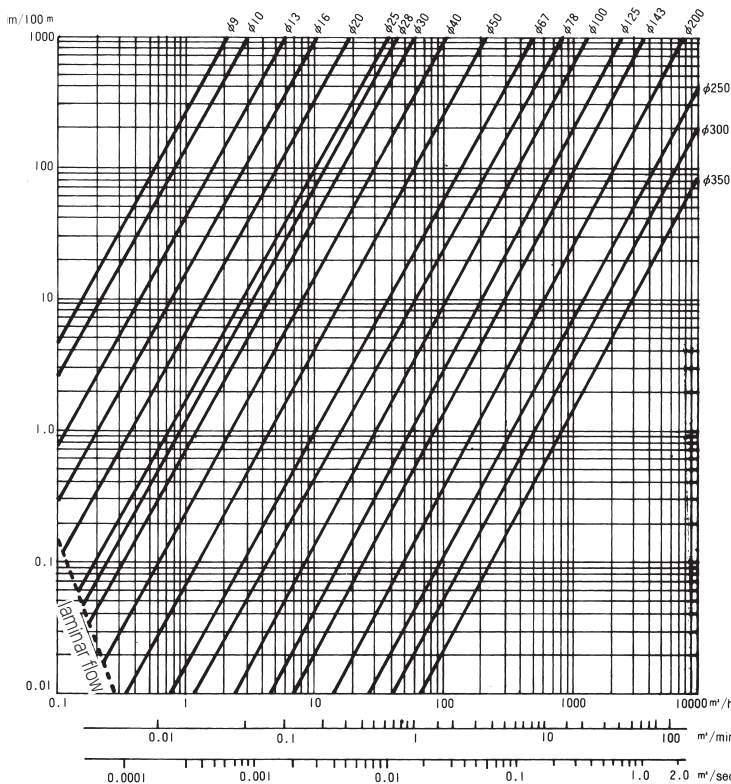

Equivalent Lengths for Valves and Couplings

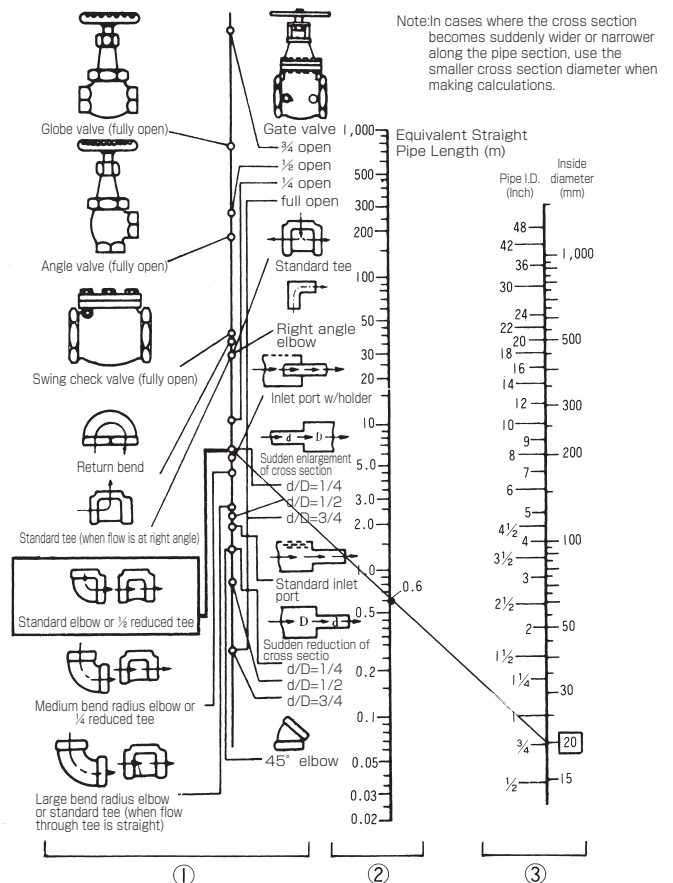

## Chiller and Unit Cooler Outline Reference

※ The number and type of functions differ according to the model. Please refer to the specifications of individual models for further details.

DC Motor Compressor - Inverter Control	Equipped with a DC twin piston rotary compressor and inverter controlled for energy savings up to 65%. <small>(Patented)</small>
Digitally Controlled Compressor	With an unloading mechanism built into the compressor, and optimal control of the load and unload cycle, both energy savings and high precision control are achieved. <small>(Patented)</small>
Compressor Inverter Control	Energy savings and high precision operation via inverter compressor frequency PID control. <small>(Patented)</small>
50/60Hz Same Power Output	No reduced cooling power when running in areas with 50Hz power.
Built-In Discharge Pump	Built-in discharge pump supplies water to your equipment (in closed loop configurations.)
Built-In Circulation Pump	Built-in circulation pump takes in and discharges chilled water (in open loop configurations.)
IPX4 Equiv. Rating Splash-proof	Outdoor installation is possible in accordance with IPX4 (JIS C 0920) standard. ※ Installation in direct sunlight, strong wind (8 m/sec or higher,) contact with falling snow, or freezing conditions requires further measures. An IPX4 rating refers to the amount and nature of water exposure equipment can withstand. Specifically, it indicates that "equipment can safely withstand contact with rain or water splash from any direction at a rate up to around 10 L/min."
IPX3 Equiv. Rating Splash-proof	Outdoor installation is possible under a roof as long as there is no direct contact with rain, in accordance with the IPX3 (JIS C 0920) standard. ※ Installation in direct sunlight, strong wind (8 m/sec or higher,) contact with falling snow, or freezing conditions requires further measures. An IPX3 rating refers to the amount and nature of water exposure equipment can withstand. Specifically, it indicates that "equipment can safely withstand water exposure at any angle from the perpendicular to within 60° , at an intensity of about 10 L/min or less."
High Efficiency Refrigerant R410A	R410A is a new refrigerant that is highly efficient and does not contribute to the destruction of the ozone.
HFC Refrigerant R407C	This equipment is adopted for use with R407C refrigerant which does not contribute to the destruction of the ozone.
Digital Temperature Control	Easy operation and setting of fluid temperature is possible with Orion's distinctive temperature control system. Furthermore, in the unlikely event that some trouble does occur, the root of the problem can be understood with just a glance of the error display code.
External Signal Terminals	Terminals are provided for an operation signal, warning signal, and remote operation.
Rated for 3 Power Sources	Works with the following power sources: three phase 200V at 50 or 60Hz, or three phase 220V at 60Hz.
Multi-Function Parameters	User adjustable parameter settings allow you to set the chiller to meet your specific needs. Settings for anti-freeze operation and warming-up modes are also available.
Freeze Prevention Mode (User selectable)	With this setting, the pump is automatically operated in order to prevent freezing of the fluid when the chiller is to be used in very cold ambient temperatures.
Warm-Up Mode	Prevents the fluid temperature from dropping below a set minimum temperature during times of operation in very cold ambient temperatures by automatically running the pump as necessary. <small>(Patented)</small>
Fluid temp high/low warning	Detects when the fluid temperature becomes abnormal.
External Communications Capability	Operation, adjustment of temperature settings and monitoring of fluid temperature, etc., all via PC. ※ Special optional control software is required.
Remote Control Panel (Optional)	A remote control unit that offers all of the control features found on the chiller's main control panel. (Available as optional equipment.)
Multi-Directional Vent	Hot ventilation exhaust can be directed as needed to better suite your working environment.
Condenser Filter Included	Comes with a condenser intake filter built-in for easy maintenance in environments that have lots of dust and dirt.
CE Marking	Product has CE Marking. This product meets the CE Marking directives set about by the European Commission (EC).

## Chiller and Unit Cooler Optional Equipment

### Remote Control (wired)



Remote Control (wired) Set

Does not include cable. Please order the cable along with the Remote Control Set.



Remote Control Cord Assembly

Part name	Part number	Applicable model
Remote Control (wired) Set A	04100607010	RKED2200A-V(W) , RKE3750~18000A-V(W)
Remote Control (wired) Set B	04100608010	RKED9000A-V RKE22000A-V(W)
Remote Control (wired) Set C	04100949010	RKE750A1-V, RKE1500B1-V(W), RKE2200B1-V(W)
Remote Control Cord Assembly (20m)	04100541010	RKE#1 and RKED Series, All Models
Remote Control Cord Assembly (50m)	04100541020	RKE#1 and RKED Series, All Models
Remote Control Cord Assembly (100m)	04100541030	RKE#1 and RKED Series, All Models

※ Chiller models made before April 2006 require a CPU replacement in order to use this remote control.

Before purchasing the Remote Control unit, please inform your dealer of the serial number of the chiller to which the Remote Control unit will be connected.

※ Does not include RKE30000A-V(W)

### Heater



Use this heater to maintain precise temperature control even when the fluid temperature is rising, during loads too low for the chiller to normally perform accurate temperature control. RKE750A-V, RKE1500B-V, RKE1500B-VW

Part name	Part number	Applicable model
Heater	03101359010	RKE750A1-V, RKE1500B1-V, RKE1500B1-VW
	03104635010	RKE2200B1-V, RKE2200B1-VW

### Ventilation Hood



※ RKE15000~30000A-V compatible items are built-to-order items.  
※ Items for RKE22000 and 30000A-V should be arranged using a special order number.

Part name	Part number	Applicable model
Ventilation Hood Set	03091229010	RKED2200A-V, RKE3750A-V
	03091231010	RKE5500A-V
	03091230010	RKE7500A-V, RKED9000A-V
	03091362010	RKE11000A-V
	03091363010	RKE15000, 18000A-V
	09-U0943	RKE22000A-V
	09-U0944	RKE30000A-V

### Communications Software



Part name	Part number	Applicable model
Communications Software	04091273010	RKE#1 and RKED Series

※ Does not include RKE30000A-V(W)

### Communications Interface



Use this interface to add external communications capability to your chiller. RKE750A-V, RKE1500B-V, RKE1500B-VW

Part name	Part number	Applicable model
Communications Interface	04101126010	RKE750A1-V, RKE1500B1-V RKE1500B1-VW, RKE2200B1-V

### Float Valve



Use for automatic water supply systems. RKE750A-V, RKE1500B-V, RKE1500B-VW

Part name	Part number	Applicable model
Float Valve	03101256010	RKE750A1-V, RKE1500B1-V RKE1500B1-VW
	03103698010	RKE2200B1-V, RKE2200B1-VW

### Snow Protection Hood



※ Items for RKE22000 and 30000A-V should be arranged using a special order number.

Part name	Part number	Applicable model
Snow Protection Hood Assembly	03091238010	RKED2200A-V
		RKE3750A-V
		RKE11000A-V (2pcs)
	03091238020	RKE5500, 7500A-V, RKED9000A-V
		RKE15000A-V(2pcs) RKE18000A-V(2pcs)
09-U0945	RKE22000A-V	
	09-U0946	RKE30000A-V

## Chiller and Unit Cooler Special Order Specifications and Optional Parts List

No	Requirements Specifications Options				Applicable Model						
	Requirement 1	Requirement 2	Requirement 3	Requirement 4	DC Inverter	RKE	RKED	RKS (with water tank)	RKS (no water tank)	RKL (no water tank)	
1	1. Cooling fluid replacement	Brine ※ 13	Naibrine Z- 1	50% or less	●	●	●	●	●	●	
			Ethylene glycol	50% or less	●	●	●	●	●	●	
		Deionized water (up to 1 μS/cm)	Contains Cu ion		Standard	Standard	Standard	Standard	Standard	Standard	
			No Cu ion present ※ 14 ※ 20		●※ 15	●※ 15	●※ 15	●	●※ 25	Standard	
2	Operable fluid temperature range	Low fluid temperature ※ 13	0 ~ 30°C		●	●	×	×	×	×	
		High fluid temperature	10 ~ 30°C		Standard	Standard	Standard	Standard	●	Standard	
3	Ambient temperature range	Cold climate model	-15°C ~ spec. upper limit		×	●※ 1	×	×	×	×	
4	Power source (Using an autotransformer) ※ 2 ※ 18 ※ 22	380V 50/60Hz			● (external)	● (external) ※ 11	● (external)	● (external)	● (external)	● (external)	
		440V 50/60Hz			● (external)	● (external) ※ 11	● (external)	● (external)	● (external)	● (external)	
		415V 50/60Hz			● (external)	● (external) ※ 11	● (external)	● (external)	● (external)	● (external)	
		440V 50/60Hz			● (external)	● (external) ※ 11	● (external)	● (external)	● (external)	● (external)	
		480V 50/60Hz			● (external)	● (external) ※ 11	● (external)	● (external)	● (external)	● (external)	
5	Pump specifications ※ 14	~ 0.1MPa	Flow rate (at required pressure)	Below minimum specified flow rate	×	×	×	×	×	×	
				Within specified range	×	×	×	×	Standard	Standard	
				Over specified range	×	×	×	×	●	●	
		~ 0.5MPa	Flow rate (at required pressure)	Below minimum specified flow rate	●	●	●	●	×	×	
				Within specified range	Standard	Standard	Standard	●	×	×	
				Over specified range	●	●	●	●	×	×	
		~ 1.0MPa	Flow rate (at required pressure)	Below minimum specified flow rate	●	●	●	●	×	×	
				Within specified range	●	●	●	●	×	×	
				Over specified range	●	●	●	●	×	×	
				Over specified range	●	●	●	●	×	×	
6	Relief valve	0.3MPa			●	●	●	●	×	×	
		0.5MPa			●	●	●	●	×	×	
		0.6MPa			●	●	●	●	×	×	
		1.0MPa			●	●	●	●	×	×	
7	Casters (Does not apply to model #s over 11000.)	With stopper	2 swivel casters		●	●	●	●	●	●	
			4 swivel casters		○	○	○	○	●	●	
		With leveling foot	2 swivel casters		●	×	×	●	●	×	
			4 swivel casters		●	○	○	●	●	●	
8	Custom coating (Regarding color, specify JPMA No. or Munsell No. from sample chart)	Acrylic resin	15 μm min.		●	Standard	Standard	●	●	Standard	
			30 μm min. ※ 8		●	●	●	●	●	●	
			45 μm min. (salt-air protection) ※ 9 ※ 17		●	●	●	●	●	●	
		Melamine resin	15 μm min.		Standard	×	×	Standard	Standard	×	
9	Installation environment	Indoors			Standard	Standard	Standard	Standard	Standard	Standard	
		IP-X3 equiv.		※ 30	●						
		IP-X4 equiv.		●※ 30	●	×	●				
		Packaging for export ※ 24		●	●	●	●	●	●		
		Clean room ※ 23		●	●	●	●	●	●		
10	External signal	Operation signal	No-voltage contacts		Standard	Standard	Standard	Standard	Standard	Standard	
			Voltage output (200V)		●	●	●	●	●	●	
		Warning signal	No-voltage contacts		Standard	Standard	Standard	Standard	Standard	Standard	
			Voltage output (200V)		●	●	●	●	●	●	
		Remote operation (alternate (continuous) input only)	No-voltage contact input	Extension length	20m max.	Standard	Standard	Standard	Standard	Standard	Standard
					100m max.	●	●	●	●	●	●
			Voltage input (DC24V)	Extension length	20m max.	●	●	●	●	●	●
					100m max.	●	●	●	●	●	●
		Remote Control ※ 16		Extension length	20m max.	○	○	○	×	×	×
					50m max.	○	○	○	×	×	×
100m max.	○				○	○	×	×	×		
11	Blackout, power-cut-off recovery operation	Manual recovery			Standard	Standard	Standard	Standard	Standard	Standard	
		Automatic recovery			●	●	●	●	●	●	
12	Circuit breaker	Leakage breaker			●※ 29	● (7500 max.)	● (2200 only)	●	●	●	
		Over current breaker			●	● (7500 max.)	● (2200 only)	●	●	●	



○ : Optional equipment ● : Available by Special Order × : Not compatible Standard: Standard configuration

No	Requirements Specification Option				Applicable Model						
	Requirement 1	Requirement 2	Requirement 3	Requirement 4	DC Inverter	RKE	RKED	RKS (with water tank)	RKS (no water tank)	RKL (no water tank)	
13	Water tank water level alarm	Water level low warning			Standard	Standard	Standard	●	×	×	
14	Piping fixtures	Water supply port	With ball valve	Specify size	●	●	●	●	×	×	
			Solenoid valve	Specify size	●	●	●	●	×	×	
		Chilled water outlet/return ports	With gate valve	Specify size	●	●	●	●	●	●	
			Solenoid valve	Specify size	●	●	●	●	×	×	
			Compression fitting	Specify size	●	×	×	●	×	×	
		Cooling water inlet/outlet ports (Water cooled models)	With gate valve	Specify size	●	●	●	●	●	×	
			Solenoid valve	Specify size	●	●	●	●	×	×	
Compression fitting	Specify size		●	×	×	●	×	×			
15	Temperature accuracy	± 0.5°C			Standard	Standard	Standard	● (Heater PID) ※ 4	×	● ※ 5	
		± 1.0°C						● (HB control)	● (HB control)		
		± 2.0°C						Standard	Standard		Standard
16	Heating function	For startup ※ 7	1kW ※ 12		● ※ 28	●	●	● ※ 6	×	×	
			2kW ※ 12		●	●	●	● ※ 6	×	×	
			3kW ※ 12		●	●	●	● ※ 6	×	×	
			4kW ※ 12		×	●	●	● ※ 6	×	×	
			5kW ※ 12		×	●	●	×	×	×	
			10kW(5kW×2) ※ 12		×	●	●	×	×	×	
17	Display language	English			●	●	●	●	●	●	
		Japanese and English			●	●	●	●	●	●	
18	Water filter	10 inch	5 μm		●	●	●	●	×	×	
			10 μm		●	●	●	●	×	×	
			25 μm		●	●	●	●	×	×	
			50 μm		●	●	●	●	×	×	
			100 μm		○	○	○	○	×	×	
		20 inch	5 μm		×	● ※ 10	×	×	×	×	×
			10 μm		×	● ※ 10	×	×	×	×	×
			25 μm		×	● ※ 10	×	×	×	×	×
			50 μm		×	● ※ 10	×	×	×	×	×
			100 μm		×	○ ※ 10	×	×	×		
19	Leak detector installation				●	●	●	●	●		
20	With anchor bolts	Stainless steel or steel			●	●	●	●	●		
21	Multi-Directional Vent	User installed		Standard ※ 30	×	×	Standard	○ ※ 25	●		
22	Snow Protection Hood	User installed		×	○ ※ 26	○ ※ 26	×	×	×		
23	Ventilation hood	User installed			○ ※ 26	○ ※ 26	×	×	×		
24	Communications Software			○ ※ 27	○	○	×	×	×		
25	Test manual	Japanese			●	●	●	●	●	●	
		English			●	●	●	●	●	●	
26	Test results chart	Japanese			●	●	●	●	●	●	
		English			●	●	●	●	●	●	
27	Initial inspection				●	●	●	●	●		
28	With eyebolts				○ ※ 30	Standard	Standard	Standard	×	Standard	
29	With float valve				○	Standard	Standard	Standard	×	×	

Note: Please be aware that specifications on this chart are subject to change without notice.

- ※ 1: Snow protection hood and ventilation hood installed. Water pressure gauge installed within unit.
- ※ 2: Since there are no eyebolts, the unit should be moved with a forklift.
- ※ 4: Chilled water must be deionized water.
- ※ 5: Modified RKE model without the water tank.
- ※ 6: Water tank will be replaced with a stainless steel tank.
- ※ 7: The heater will switch on and off at a temperature 2°C lower than the set fluid temperature (± 0.5°C).
- ※ 8: Exterior screws are stainless steel.
- ※ 9: Stainless steel exterior use screws as well as polyurethane coating of the refrigerant piping and condenser.
- ※ 10: For RKE5500 models and above.
- ※ 11: Included with RKE15000 models and higher. (external installation)
- ※ 12: AC200V only.
- ※ 13: Cooling capacity decreased by 20%.
- ※ 14: Cooling capacity will be decreased by an amount equal to the heat output of the pump.
- ※ 15: Fluid temperature range will be at least 20°C.
- ※ 16: When special ordered, the unit will be shipped with a power supply unit pre-installed

- ※ 17: Refrigerant piping can also be coated but is not covered under the long term warranty.
- ※ 20: Equipped with circulation and discharge pumps.
- ※ 22: IPX rating matches that of the main unit.
- ※ 23: These models are equipped with a leakage sensor, pressure resistant piping, refrigerant piping insulation, and water piping insulation. (Does not take into account particle debris from unit.)
- ※ 24: Packaged in a plywood packing crate.
- ※ 25: Comes standard with RKS1500F models.
- ※ 26: Available as an option on air cooled models only. (RKE22000A-V and higher models require special order.)
- ※ 27: RKE750A1-V, RKE1500B1-V(W), and RKE2200B1-V(W) models require preparation of separate communications assemblies.
- ※ 28: RKE750A-V and RKE1500B-V(W) models have a "Heater option" configuration. (1.5kW)
- ※ 29: Standard equipment on RKE2200B1-V(W).
- ※ 30: RKE2200B1-V(W) is outside the target use.
- ※ 31: RKE7500A-V, RKL5500-D, and RKL7500-D models require chartered shipment.

# Fluid Temperature Control Equipment [With Built-in Water Tank]

**ORION**

Patented

## High Accuracy Water Temperature Control Unit

Fluid Temperature Control Equipment

# PEC® Series Precision Chiller [Heat Pump Balance® Temperature Control Unit]

**Model** [PEC400B1-VW/PEC900B1-VW/PEC1500A1-V (Built-to order)]

The ORION Precision Chillers (PEC Series) are the complete culmination of ORION Refrigeration Technology, comprising refrigeration circuits originally developed at ORION that offer extreme energy savings along with high accuracy. **Patented**

Control temperature:  $\pm 0.05^{\circ}\text{C}$

Temperature control range:  $10.00\sim 60.00^{\circ}\text{C}$

Value indicates maximum value of a particular model in this chiller series. Actual value will depend on the specific model.

Cooling capacity:  $1.0\sim 6.2\text{kW}$

A heat pump balance control that offers super energy savings and high accuracy temperature control.

(Energy savings as much as 80%, and temperature control as high as  $\pm 0.05^{\circ}\text{C}$ .)

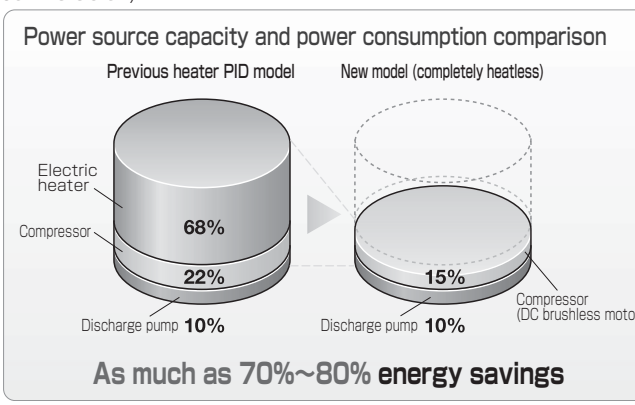

"Heatless" design works with wide watercontrol ranges. (PEC400B1-VW:  $10^{\circ}\text{C}\sim 60^{\circ}\text{C}$ )

Multi-function control panel for access to many operational functions.

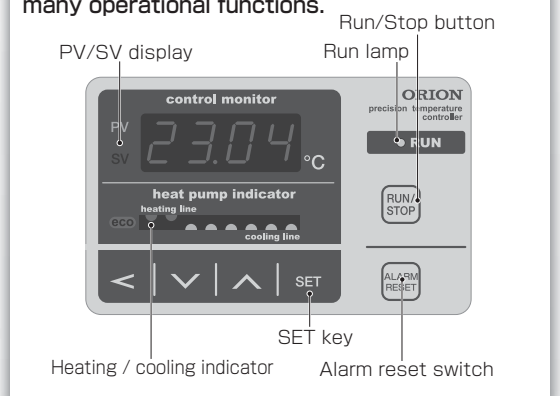

**Space saving design.**

Heat exchanger (evaporator), tank, and pump are all built into the main unit.

- Water cooled double pipe heat exchanger
- Refrigerant control unit for heat pump balance control
- Special circuit board
- High-head pump
- Stainless steel tank
- Compressor with built in DC brushless motor.



## Specifications

Model		PEC400B1-VW	PEC900B1-VW	PEC1500A1-V (Built To Order)	
Performance specifications	Operating fluid	Water			
	Temperature control range	℃	10.0~60.0	10.0~45.0	15.0~35.0
	Temperature control accuracy ※ 1	℃	Max. 0.05		
	Control method	Heat pump balance control			
	Cooling capacity ※ 2	kW	1.0	4.0	6.2
	Heating capacity ※ 3	kW	1.0	4.0	6.2
Circulating water	Ambient temp. range	℃	10~40	15~35	
	Operating pressure(50/60Hz)	MPa	0.13~0.25	0.13~0.27/0.18~0.41	
	Minimum operating circulation rate (50/60Hz)	L/min.	18/26 (Head:25m)	40 (Head: 26/40m)	
	Outlet port size		Rc1/2	Rc3/4	
Heat dissipating water	Inlet port size		Rc1/2	Rc3/4	
	Operating temperature range	℃	15~32	15~32	----
	Operating pressure	MPa	0.69 or less	0.69	----
Power specifications	Outlet port size		Rc1/2	Rc3/4	----
	Power source ※ 4	V(Hz)	Three-phase 200 ± 10%		
	Power consumption(50/60Hz, 220V) ※ 5	kW	1.2/1.4	2.2	3.3/3.5
	Electric current (50/60Hz) ※ 5	A	5.2/5.4	7.8	12.0/12.2
	Power capacity ※ 6	kVA	1.9	2.8	4.2
	Operating noise level (50/60Hz)	dB	67	57	69
	Refrigerant		R134a	R410A	
Mass	kg	100	220	295	
External dimensions (H×D× W)	mm	1200×600×450	1500×900×640	1600×900×640	

※ 1 During continuous operation when load fluctuation stays within ± 10%. Also, when the load and cooling water temperature and flow rate are stable, the control accuracy is ± 0.05℃. ※ 2, ※ 3 Performance figures based on the following operating standard: Process water temperature: 23℃, radiated heat cooling water temperature: 23℃. Cooling and heating capacity will not be lower than the noted capacity minus 5%. ※ 4 Source voltage phase unbalance should be less than ± 3%. ※ 5 Maximum value within the range of unit specifications. ※ 6 At the maximum operating current within the rated operating range.

## External dimensions

PEC400B1-VW

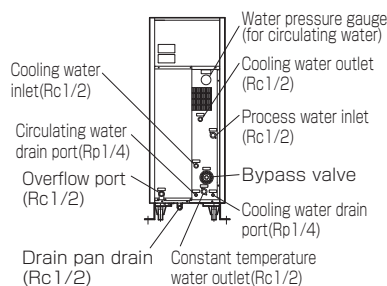
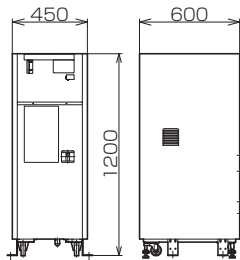
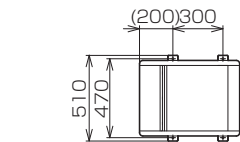

PEC900B1-VW

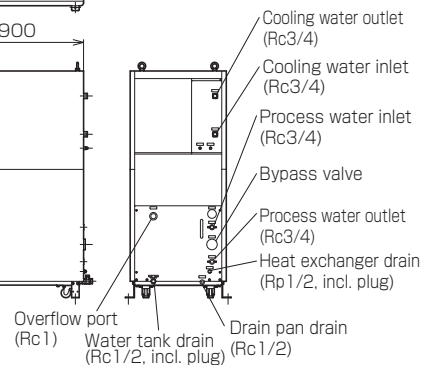
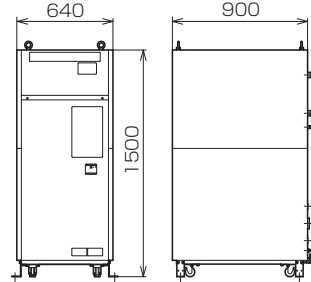
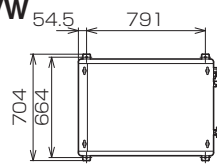

(Units: mm)

## Cooling Capacity

PEC400B1-VW

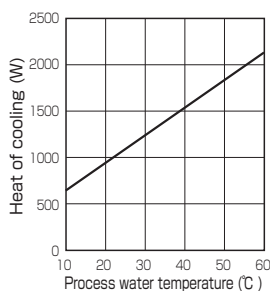

Conditions: cooling water temperature: 23℃  
· Process water flow rate: 30L/min  
· Ambient temperature 23℃

PEC900B1-VW

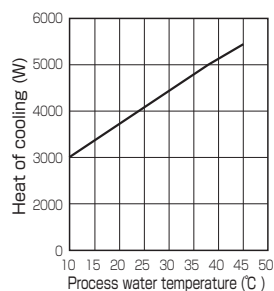

Conditions: cooling water temperature: 23℃  
· Process water flow rate: 40L/min  
· Ambient temperature 23℃

## Discharge Pump Characteristics

PEC400B1-VW

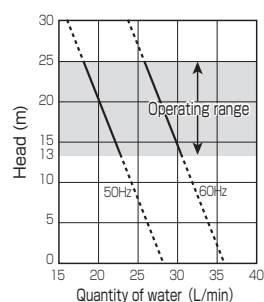

PEC900B1-VW

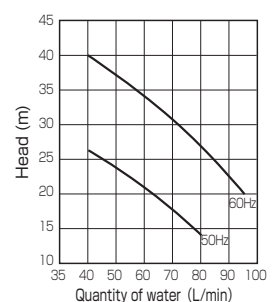

# Fluid Temperature Control Equipment **ORION**

## Compact Fluid Cooling Unit

Thermoelectric Equipment

# Carry Cool®

### Features

#### [Immersion type (LPC1-J / LPC2-J / LPC2)]

##### ● Just put the cooling coil into the water tank for easy fluid cooling.

- Just put the cooling coil into the water tank for easy cooling.
- Light weight design for easy portability and installation.
- Superior chemical resistant cooling coil. (SUS304 and titanium types available.)
- Temperature controller installation possible.

[Optional equipment: For fixed temperature control.]

#### [Circulation type (LPB3)]

##### ● Circulation type chiller with built-in pump and heater. PID control for highly accurate fluid temperature control over a wide range of temperatures from -20 to +40°C.

- Utilizes a highly efficient cooling method.
- Offers high accuracy temperature control.
- PID control and easy to read digital display.

LPC1-J  
LPC2-J  
LPC2



Immersion compatible temperature controller (optional)



LPB3

### Specifications

Item	Model	LPC1-J	LPC2	LPC2-J	LPB3
Operating fluid		Industrial-use ethylene glycol water solution * 1			
Performance specifications	Temperature control range	-20~30 *2			-20~40
	Control method	*2			PID control, command/setting resolution: 0.1°C
	Cooling capacity	160/190 *3	370/430 *3		500/520 *3
	Heating capacity	—	—	—	1,000
	Circulation rate	—	—	—	10~16/10~18.5
Ambient temp. range	°C	10~35			
Outlet / Inlet connection		—	—	—	Rp3/4
Power specifications	Power source	Single phase 100 (50/60) * 3			
	Maximum operating current	3.8/3.5	4.0/4.1		16.5/15.8
	Power supply capacity	0.4	0.4/0.5		1.7/1.6
	Breaker capacity	10			20
Refrigerant		R134a			R404A
Evaporator material properties		Titanium	SUS304	Titanium	Shell: PBT, Coil:SUS304
External surfaces		Custom coating: Munsell No.10Y8.5/1			
Mass	kg	Approx. 18	Approx. 19		Approx. 37
External dimensions WxDxH	mm	290×210×370			454×375×427

\* 1 At a high enough concentration to avoid freezing. \* 2 For controlled operation, the optional temperature controller (ON/OFF control) is required. \* 3 During the following conditions: Fluid temperature: 15°C, ambient temperature: 25°C.

### External dimensions

#### LPC1-J / LPC2-J / LPC2

(Units: mm)

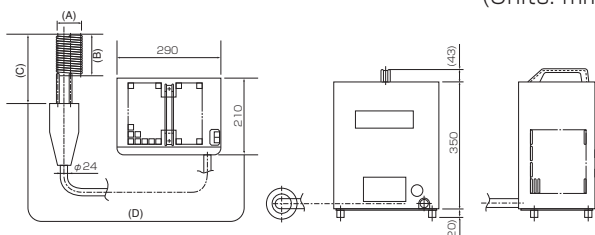

	A	B	C	D
LPC1-J	φ 66	130	190	1000
LPC2-J	φ 78	210	270	1000
LPC2	φ 78	200	330	940

#### LPB3

(Units: mm)

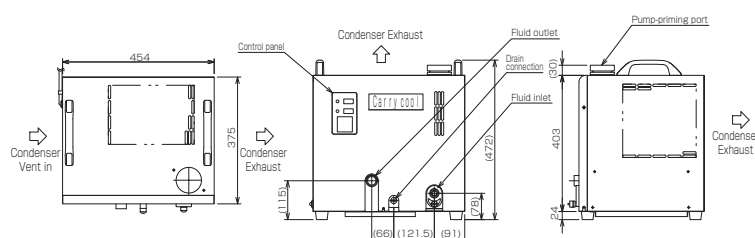

# Chilled Water Supply Equipment

**ORION**
**Cold water available anytime, with just this one unit.**

Refrigeration Equipment

## One Way Chiller®

### Features

1. The long awaited large capacity model (2200B) is available. Can supply 10°C water at 7 L/min ((water supply temp.: 25°C , 60Hz operation)
2. Comes standard with remote control unit (incl. 10m cord)
3. Outside use possible (Protection class IPX4)
4. Operable ambient temperature range increased to -5°C – 43°C .
5. HFC Refrigerant



RKP2200B

### Specifications

Item	Model	RKP1500B	RKP2200B	
Cooling capacity (50/60Hz) ※ 1	L/min	3.9/4.5	6.1/7.0	
External		SUS304(2B)		
External dimensions (HxDxW)	mm	1080×390×780	1195×390×780	
Mass	kg	Approx. 100	Approx. 110	
Water intake port size		Rp 1/2	Rp 3/4	
Cooling water outlet size		Rp 1/2	Rp 3/4	
Ambient temp. range	°C	-5~43		
Operable water supply temperature range	°C	15~30		
Operable water supply pressure range	MPa	0.69 or less		
Power specifications	Power source	V(Hz)		
	Operating current ※ 1	A	Three-phase 200 ± 10% (50/60), 220 ± 10% (60)	
	Power consumption ※ 1	kW	5.8/6.5, 6.5	10.3/11.4, 11.4
	Power capacity ※ 2	kVA	3.3	5.5
Unit specifications	Compressor / Rated output	W	Fully sealed rotary type / 1400	Fully sealed scroll type / 2200
	Condenser		Fin and tube forced air cooling	
	Evaporator construction		Double pipe construction	
	Refrigerant		R-407C	
	Refrigerant circuit control method		Flow switch	
	Refrigerant control method		Capillary tube	
	Fan motor output	W	100	
	Operation control panel		Digital electronic control panel (incl. remote control unit)	

※ 1 Operation in the following conditions: Ambient temperature: 32°C , Water supply temperature: 25°C , chilled water temperature: 10°C . Chilled water discharge capacity is at least 95% of listed figures.

※ 2 The figure noted is when the equipment is operating at the highest capacity of its normal operating range.

Note: If water purification devices are to be used, install them on the outlet side (near the faucet). (Water pressure lowered to 0.08 MPa.)

### Cooling Capacity

RKP1500B

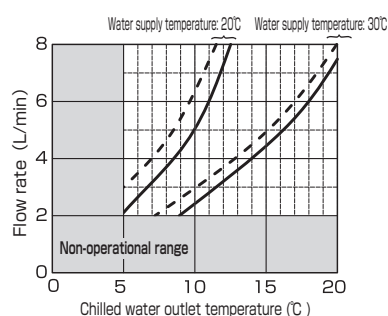

RKP2200B

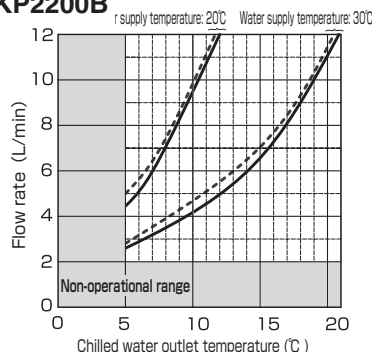

Ambient temperature : 32°C  
 — : 50Hz  
 - - - : 60Hz

# Stored-Ice Water Cooling Unit (Built to order)

ORION

Patented

Ice collected at night used for ice water supply (0 ~ 5°C) in the daytime. Control power usage during peak daytime hours. Refrigeration Equipment



RT55B

RT130B

## Features

- Highly efficiency ice storage thanks to our special plate and microprocessor control (freezing ⇄ ice removing)

- High cooling efficiency from good surface contact with refrigerant gas.
- Built in circulation pump and "freezing ⇄ ice removing" system

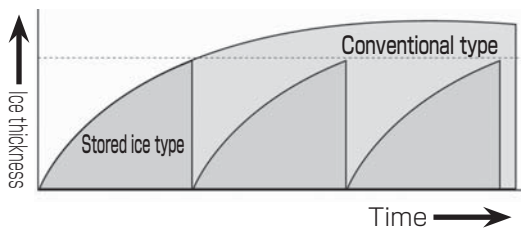

### ● Special plate (ORION only)

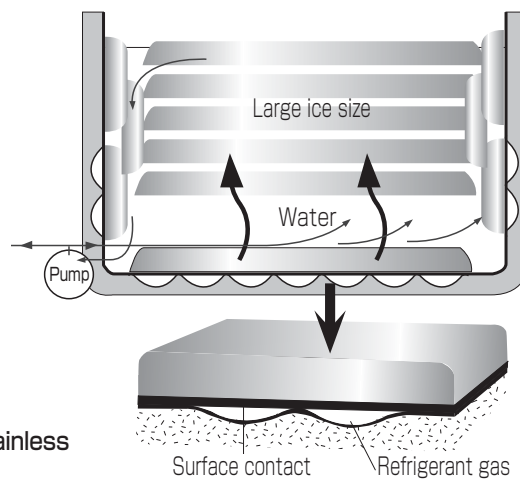

### ● Coil transmission method (other company)

(Poor cooling efficiency)

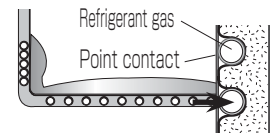

Point contact between refrigerant gas pipe and the stainless steel tank results in poor cooling efficiency.

### ● Coil · direct expansion type (other company)

(Drop in cooling efficiency)

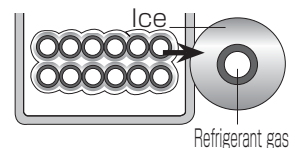

Ice thicker than 20mm results in drop in cooling efficiency. (Low ice formation)

- Fewer cooling coils, etc., and easy to clean stainless steel water tank.
- Lower running cost thanks to our smaller compressor.
- A lineup that fits your needs.
- Built-in cooling water discharge pump (for combined circulation)
- Operation via a full function, all encompassing control panel (with easy to read icons display.)

Easy to understand icons make our control panel easy to operate. Lighted parts use highintensity LEDs for a brighter, easier to see display.

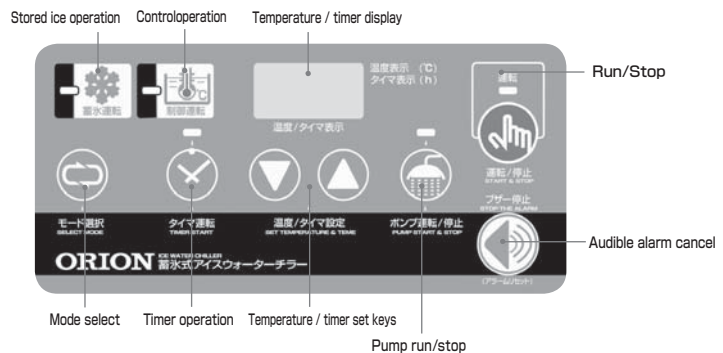

- Control box available for remote operation.

The control box can be moved or attached to the wall or other surface.

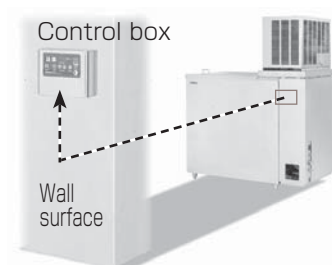

## Specifications

Item	Model	RT55B (Combined component area type)	RT130B (Separate type)	
Water tank capacity	L	550	1300	
External dimensions	Main unit External dimensions	Width mm	1550	
		Depth mm	845	
		Height mm	1772~1807	
	External unit dimensions	Width mm	—	
		Depth mm	—	
Height mm		—		
Mass	Main unit	kg	291	
	Component area part	kg	69	
	External unit	kg	—	
Material	Main unit external surfaces	SUS304		
	Main unit water tank interior	SUS304+PVC		
	External unit	Painting( beige)		
Operating conditions	℃	Ambient temperature: 5 - 35, Water supply temperature: (Intake water temperature for the RT130 model): 0 - 30.		
Temperature setting range ※ 1	℃	0 - 30 (Control mode setting possible)		
Performance specifications (20/20℃)	Cooling capacity ※ 2	kW	2.50/2.93	
	Stored ice capacity ※ 3	10 hours	kg	130/135
		13 hours	kg	145/155
		16 hours	kg	190/205
Connection port size	Water supply port		Rp 1/2	
	Cooling water outlet		Rp 3/4	
	Cooling water return port		Rp 1 1/4	
	Drainage port		Rc 1	
Power specifications	Power source	V(Hz)	Three phase 200 (50/60)	
	Operating current ※ 2	A	8.3/9.2	
	Power consumption ※ 2	kW	2.2/2.7	
Unit specifications	Compressor rated output	kW	1.5	
	Refrigerant		R404A	
	Refrigeration unit		Plate type (SUS304)	
	Circulation / discharge pump	W	Magnetic drive 400	
	Temperature control method		Electronic digital setting	
	Timer delay start time		1 ~99 hours (non-repeating)	
Water supply method		Ball tap SH13-3		

※ 1 Control temperature must be at or below the water supply temperature. The discharge temperature will depend on the discharge rate and amount of stored ice.

※ 2 Internal water temperature: 10℃ , external temperature: 30℃ , cooling capacity is at least 95% of the displayed capacity.

※ 3 Amount of stored ice after the internal water temperature has dropped to 2℃ .

## External dimensions

### RT55B

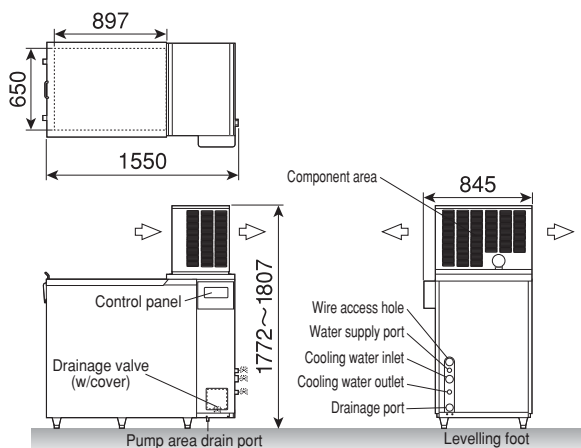

### RT130B

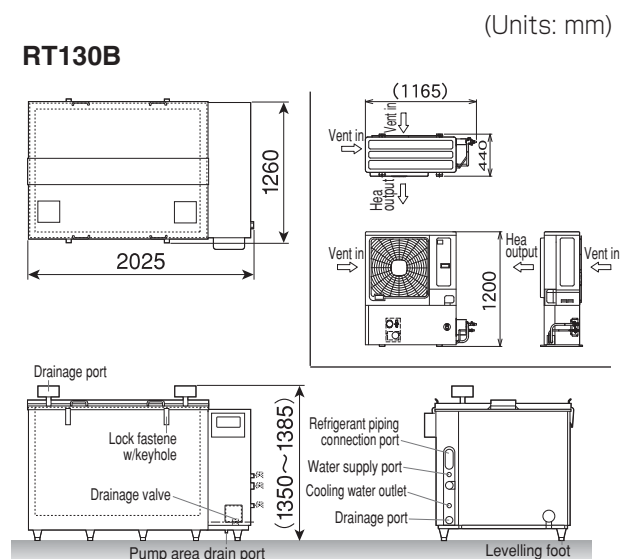

# Fluid Temperature Control Equipment

**ORION**

## Water Temperature Control Unit

Thermoelectric Equipment

# Pel Thermo®

The Pel Thermo® is a high-accuracy, compact chiller. Thanks to Peltier temperature control,  $\pm 0.1^{\circ}\text{C}$  of accuracy (or  $\pm 0.01^{\circ}\text{C}$  accuracy on special order models) is possible.

- $\pm 0.1^{\circ}\text{C}$  temperature control by thermoelectric cooling and heating.
- Most compact and most light weight unit in the industry.
- PID Auto-tuning functionality.

### Typical applications

Optimum solution for semiconductor, liquid crystal, optical disc, bio-related, and similar applications.

- Wafer resist fluid temperature control
- Etching fluid temperature control
- Optical disk fluid application temperature control
- Liquid crystal glass fluid application temperature control
- Wafer, glass, PCB plating temperature control

※ Apply indirect temperature control for liquid chemical temperature control applications.

 ETS101  
 ETS202

### Specifications

Item		Model		ETS101	ETS202
Operating fluid		Water			
Performance specifications	Temperature control range	$^{\circ}\text{C}$ 10.00~50.00			
	Control accuracy	$^{\circ}\text{C}$ $\pm 0.1$ (during no load, stable operation) ※ $\pm 0.01$ response possible on special-order models.			
	Control method	Thermoelectric cooling, PID control auto-tuning, 4-digit digital display (minimum $0.01^{\circ}\text{C}$ ) control temperature sensor: Pt100 $\Omega$ .			
	Cooling capacity (50/60Hz) ※1	W		116/104	232/220
	Circulating load (Head)	Water bearing pressure: 0.2 MPa, Flow rate: 5L/min (5.9/9.0m)			
Ambient temp. range		$^{\circ}\text{C}$ 2~35			
Outlet / Inlet connection		R c 3/8			
Power specifications	Power source	V(Hz)		Single phase 100 (50/60)	Single phase 200 (50/60)
	Maximum operating current	A		5.5	5
	Power supply capacity	kVA		0.6	1
	Breaker capacity	A		10	
Heat dissipating water	Flow rate	L/min		3~10	
	Water bearing pressure	MPa		0.4	
	Connection port	Rc3/8			
Tank capacity		L			
Wetted parts material	Process water	Special graphite, PP, NBR, POM			
	Cooling	Special graphite, POM, NBR			
External surfaces		Munsell No..5Y7/1 G-20			
Safety devices ※ 2		Alarm: 1. Thermo-module disconnected 2. Pt100 $\Omega$ shorted, disconnected 3. Abnormal radiated heat (power source, heat exchanger) 4. Temperature upper/lower limit alarm			
Configuration		Power supply unit	Cooling unit	Power supply unit	Cooling unit
Model		ETS101-DR-B-G1	ETS101-N-G1	ETS202-DR-B-G1	ETS202-N-G1
Mass	kg	Approx. 4.3	Approx. 9.5	Approx. 5.5	Approx. 10
Combined(set)mass	kg	Approx. 13.8		Approx. 15.5	
External dimensions (HxDxW)	mm	Power unit (ETS101/202-DR-B): 127 × 340 × 150 Cooling unit (ETS101/202-N): 262 × 340 × 150			

※ 1 Temperature setting:  $20^{\circ}\text{C}$ , cooling water temperature:  $20^{\circ}\text{C}$ , cooling water flow rate: 5L/min, process water flow rate: 5L/min.

※ 2 Operation will continue in case of safety device item 4. In case other safety devices are activated, unit operation will stop.



**External dimensions**

ETS 101 · 202

Power supply unit

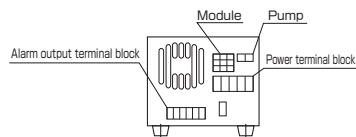
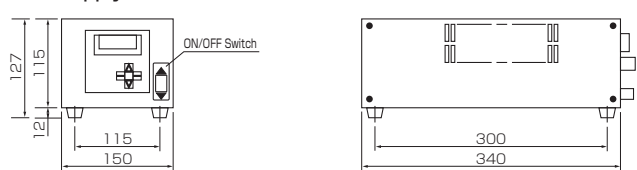

(Units: mm)

Cooling unit

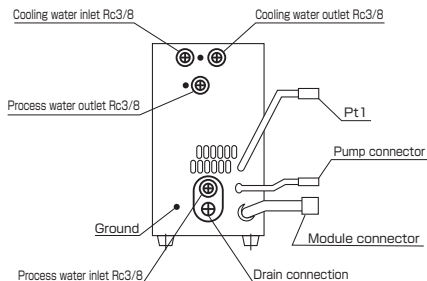
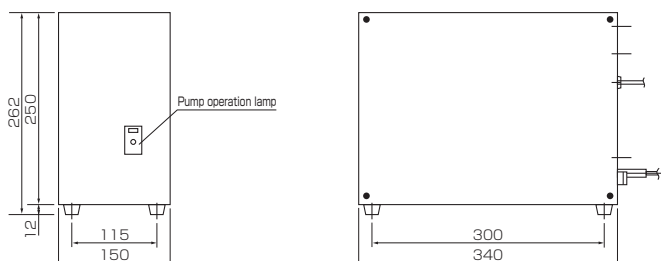

Optimal system support for combined cost, power, and accuracy.

**Working principles -- Diagrams**

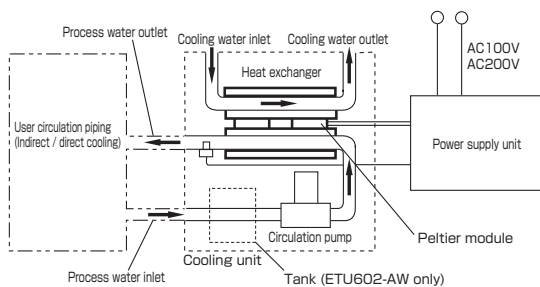

**Cooling Capacity Curves**

Cooling Performance Specifications

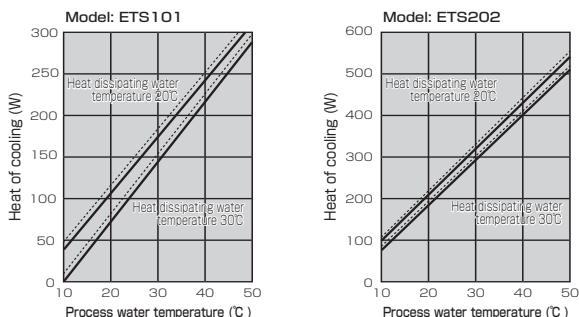

Cooling capacity conditions: Heat dissipating water flow rate: 5L/min  
: Process water flow rate 5L/min  
50Hz ———  
60Hz ———

**Process Temperature Water Circuit Illustration**

Open loop circuit configuration

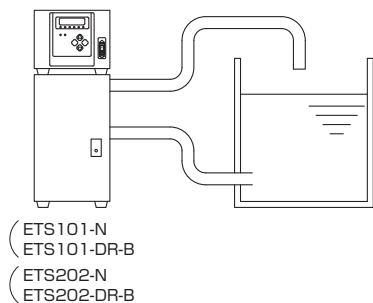

# Fluid Temperature Control Equipment

**ORION**

## High Accuracy Water Temperature Control Unit

Refrigeration Equipment

### Thermoelectric Cooling Chiller

- High accuracy fluid temperature control to within  $\pm 0.05^{\circ}\text{C}$ .



#### Typical applications

- YAG laser marker/trimmer
- LD type printing machine
- High accuracy temperature control for scientific physics and chemistry applications

#### Specifications

Item	Model	EKS250-G2
Performance specifications	Operating fluid	Clean water / distilled water
	Temperature control range	$^{\circ}\text{C}$ 15~30
	Temperature control accuracy ※1	$^{\circ}\text{C}$ $\pm 0.05$
	Control method	Electronic refrigeration, PID control auto tuning
	Cooling capacity ※2	W 250 min.
	Circulating load (Head)	L/min 1.2 (35m)
Power specifications	Ambient temp. range	$^{\circ}\text{C}$ 10~35
	Power source	V(Hz) Single phase 200~240 $\pm$ 10% (50/60)
	Maximum operating current	A 5.0
	Power supply capacity	kVA 1.5
	Breaker capacity	A 10
	Heat radiation method	Air Cooled
	Tank capacity	L 0.5
Mass ※3	kg 35	
External dimensions (HxDxW)	mm 595x456x327	

※ 1 During a stable load under the following conditions: Ambient temperature:  $25^{\circ}\text{C}$ , water temperature:  $25^{\circ}\text{C}$ . (May differ depending on specific conditions.)  
 ※ 2 Under the following conditions: Ambient temperature:  $25^{\circ}\text{C}$ , water temperature:  $25^{\circ}\text{C}$ . (May differ depending on specific conditions.)  
 ※ 3 Under dry conditions

#### Cooling Capacity

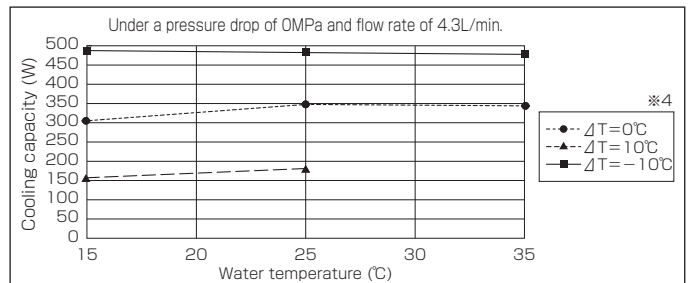
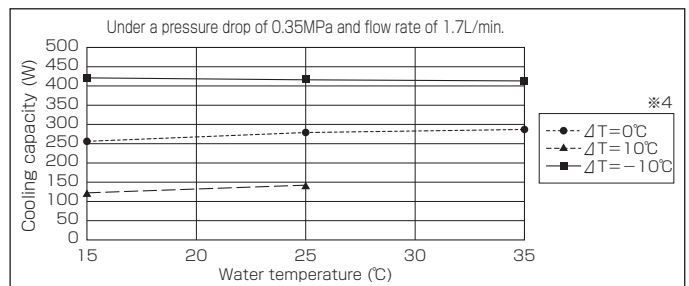

※ 4  $\Delta T = \text{ambient temp} - \text{preset temp}$

#### External dimensions

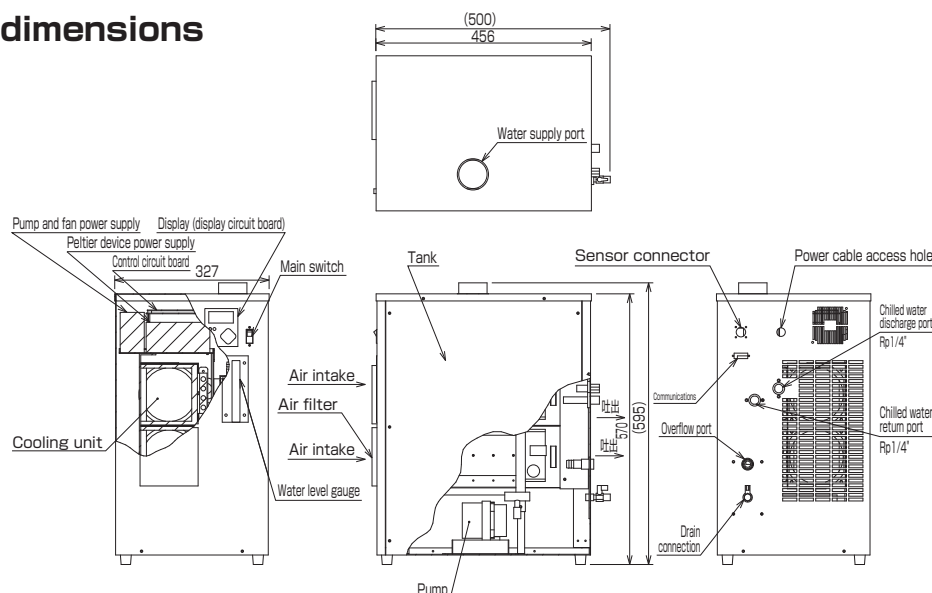

(Units: mm)

# Fluid Temperature Control Equipment

ORION

Patented

## Electronic Chemical Fluid Temperature Control Unit

Thermoelectric Equipment

### Chemical Pel Thermo®

#### ■ Cooling Unit

High accuracy temperature control unit for direct temperature control of the chemical fluids that are indispensable in wet processes. All-Teflon evaporator is suitable for all types of chemical fluids.

- High accurate temperature control and a high water bearing pressure evaporator.  $\pm 0.1^{\circ}\text{C}$  control and 0.3 MPa water bearing pressure construction
- Direct chemical fluid temperature control (Patented)
- The most compact, light weight unit in the industry. Special switching power supply.

#### ■ Power Supply Unit



### ■ Specifications

Item	Model	Cooling unit			
		ETN23A-N	ETN45A-N	ETN90A-N	
Operating fluid	※1	DIW/DHF/BHF/FPM/SC1			
Performance specifications	Temperature control range	$^{\circ}\text{C}$ 15~50 (Please ask regarding temperature control ranges over 50 $^{\circ}\text{C}$ )			
	Control accuracy	$^{\circ}\text{C}$ $\pm 0.1$ (Subject to conditions)			
	Cooling capacity / Heating power ※2	W	Approx. 280 / Approx. 600	Approx. 460 / Approx. 1,000	Approx. 920 / Approx. 2,000
	Radiated heat (cooling) method		Thermoelectric cooling / Water cooled model		
	Control temperature sensor		Pt100 $\Omega$ (JIS 0.2 class tolerance) with Teflon molding (optional)		
	Internal pressure loss (chemical fluid side)	MPa	0.01 or less (flow rate 15 L/min)		0.02 (at a flow rate of 15 L/min)
Internal pressure resistance (chemical fluid side)	MPa	0.3			
Ambient temp. range	$^{\circ}\text{C}$	15~35			
Chemical fluid side outlet/inlet connections		3/4"×5/8"×L150 (NEW PFA)			
Heat dissipating water	Flow rate	L/min	5~7		
	Connection port		3/8"×1/4"×L150 (PFA)		
Material properties of wetted parts of heat exchanger	Chemical fluid side		PTFE, New PFA		
	Cooling water side		Graphite, PPE, SUS316, PFA, NBR	SUS304, 316, PFA	
External surfaces		Hardened PVC			
Mass	kg	Approx. 10	Approx. 14	Approx. 28.5	
External dimensions (H x D x W)	mm	220×330×147		260×530×145	

Item	Model	Power supply unit		
		ETD232-SA-A-G2	ETD452-SA-G2	ETD832-SA-G2
Input current (for AC208V)	A	Max. approx. 4.5	Max. approx. 9	max. approx. 17
Power source	V(Hz)	Single phase 200~240 (50/60)		
Control method		PID control, Auto-tuning		
Built-in safety devices	※3	Alarm: 1. Thermo-module disconnected 2. Pt100 $\Omega$ shorted, disconnected 3. Abnormal radiated heat (power source, heat exchanger) 4. Temperature upper/lower limit alarm		
Mass	kg	Approx. 5.0	Approx. 10	Approx. 18
External dimensions (H x D x W)	mm	165×430×140	215×460×165	305×470×240

※ 1 Please ask regarding concentrations and/or chemical use outside the listed specifications. (The unit might not be able to operated depending on the concentration.)

※ 2 During operation under the following conditions: Temperature setting: 25 $^{\circ}\text{C}$ , Heat dissipating water: 25 $^{\circ}\text{C}$ , Water flow rate: 5 ~ 7 L/min, Ambient temperature: 25 $^{\circ}\text{C}$ .

※ 3 When a built-in safety device has activated, operation will continue only if the alarm is, "4. Temperature upper/lower limit alarm". Operation will stop for all other alarms.

### ■ External dimensions

#### Cooling unit

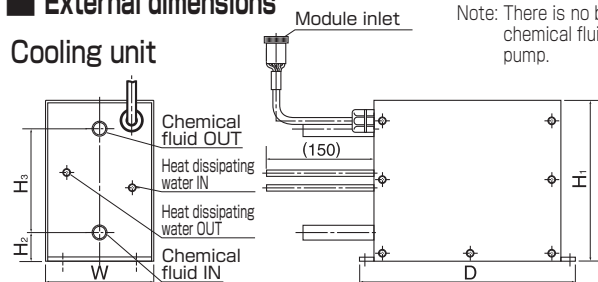

Model	W	D	H <sub>1</sub>	H <sub>2</sub>	H <sub>3</sub>
ETN23A-N					
ETN45A-N	147	330	220	40.5	136
ETN90A-N	145	530	260	44.5	

#### Power supply unit

Note: Connector is a receptacle type

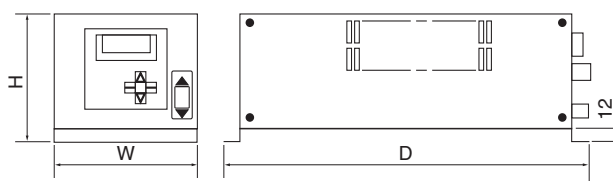

Model	W	D	H
ETD232-SA-A	140	430	165
ETD452-SA	165	460	215
ETD832-SA	240	470	305

# Water Filtering Equipment

**ORION**

Helps to prevent clogging within the water circuit of chillers and other equipment.  
Can also be used as a pre-filter for water purification equipment.

Refrigeration Equipment

## Features

1. Wall mount type for easy cartridge replacement.
2. Includes ball valves as standard equipment.
3. Manufactured with a polypropylene core that has outstanding chemical resistance properties.



Water filter: A-assembly

Water filter: B-assembly

## Specifications

Model		Water filter: A-assembly	Water filter: B-assembly	Water filter: C-assembly	
Part number		04100489010	04100491010	04100490010	
Applicable models		RKS400F-VS,RKS400F1-V, RKE750A1-V,RKE1500B1-V(W), RKED2200A-V(W),RKE2200B1-V(W), RKE3750A-V(W)	RKE5500A-V(W),RKE7500A-V(W), RKED9000A-V	RKE11000A-V(W)	
Operating ranges	Maximum working pressure	MPa	0.5		
	Maximum working temperature	°C	50		
Performance specifications	Degree of filtration	μm	100		
	Initial element pressure loss	MPa	0.02 (flow rate 43 L/min)	0.02 (flow rate 125 L/min)	0.02 (flow rate 140 L/min)
Main dimensions specifications	Piping connection size		Rc1/2 (Rc1) ※	Rc1	Rc1 · 1/4
	Mass	kg	6.3	8.0	10.0
Element model number		WPX100BB97P	WPX100BB20P		
Element part number		40605000190	40605000180		

Note: Configuration for use with RKE15000A-V(W) models and higher are special order items. ※ Can be replaced by removing the 1×1/4B adaptor bushing.

## Outside dimensions

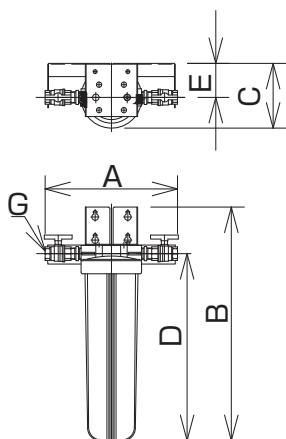

### Mounting hole positions

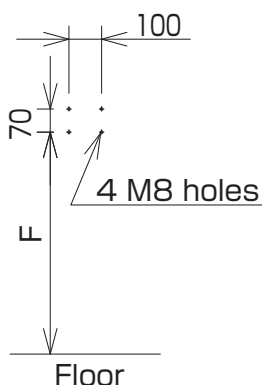

((Units:mm))

Model	Water filter:A-assembly	Water filter:B-assembly	Water filter:C-assembly
A	(435)	(405)	(449)
B	458	708	715
C	197	197	197
D	312	562	565
E	103	103	103
F	423min.	673min.	680min.
G	Rc1/2	Rc1	Rc1 · 1/4

## Stand Mount (optional) [Part no.: 04100569010]

- Works with all filters, Deionizer D-assembly, and Deionizer E-assembly.
- 2 filters can be mounted one over the other on a single stand allowing for space saving configurations, such as having a water filter mounted over an ion exchange filter.

### Dimensions (Units: mm)

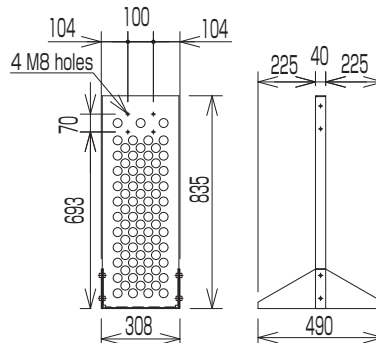

# Ion Exchange Resin Purifying Equipment

**ORION**

Cartridge and Filter types for easy connections.  
Water purification without the hassle!

Refrigeration Equipment

## For circulating water setups

(Installed in a bypass configuration, it can help protect against rising electrical conductivity within the water circuit.)

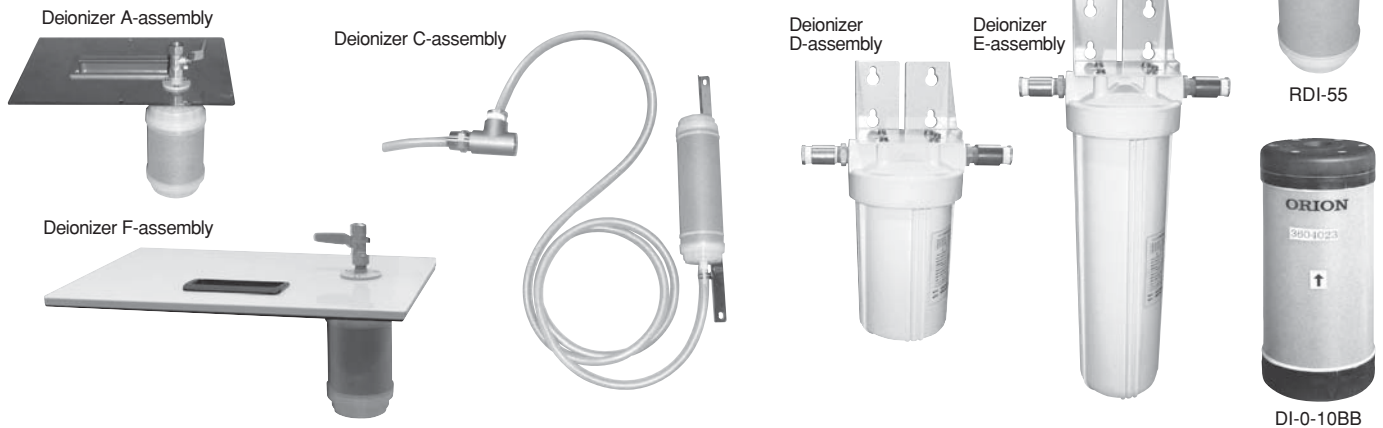

Model	Deionizer A-assembly	Deionizer F-assembly	Deionizer G-assembly	Deionizer C-assembly	Deionizer D-assembly	Deionizer E-assembly
Part number	04100553010	04101157010	04103028010	04100614010	04100597010	04100437010
Applicable models	RKS400F-VS, RKS400F1-V	RKE750A1-V, RKE1500B1-V(W)	RKE2200B1-V(W)	RKED2200A-V(W), RKE3750A-V(W)	RKE5500A-V(W), RKE7500A-V(W), RKED9000A-V	RKE11000A-V(W) and above
Ion Exchange Resin	RDI-55			RDI-150	DI-0-10BB	DI-0-20BB
Ion exchange resin part number	0A001386000			0A001387000	0A001108000	0A001017000
Processing capacity ※ 1,2	L	approx. 55L		approx. 150L	approx. 600L	approx. 1600L
Water quality	μS/cm	10 max.				
Working water pressure	MPa	0.05~0.2 ※5				
Working water temperature	°C	5~40				
Dimensions		φ 74.5 – H122mm (ion exchange resin)		φ 74.5 – H248mm (ion exchange resin)	φ 185 – H449mm	φ 185 – H592mm
Mass	g	approx. 270 (ion exchange resin)		approx. 670 (ion exchange resin)	approx. 5700	approx. 8600
Type of installation		Under the water tank cover	Under the upper cabinet panel	On the side of the unit	On a wall ※ 4	
Inlet/Outlet piping fixture		-			Rc 1/2	
Included parts		Spare deionizer ※3 Tank cover, ball valve	Spare deionizer ※3 cabinet top panel, ball valve		Spare deionizer ※3 ball valve, Mounting hardware Hose nipple, hose band Tee coupling, nipple, hose	Mounting bracket, resin nipple, socket, bushing (preassembled on the filter) Filter removal wrench

※ 1 Processing capacity figure based on water source standard purity level of 150 μS/cm. Capacity may vary according to water quality. ※ 2 Processing capacity is not based on circulating water flow system. Ion exchange resin lifespan and water quality may fluctuate depending on the properties of the wetted parts and surfaces, as well as the particular working environment.  
 ※ 3 It is recommended that the initially supplied water be either water that has been purified by having passed through an ion exchange resin, or be commercially purchased deionized water. If tap water (or a similar grade of water) is used, the effective life of the ion exchange resin will be greatly reduced. In this case, please replace the ion exchange resin with the spare soon. (Ion exchange resin assemblies A, B, C, and F only) ※ 4 Ion exchange resin assemblies D and E are wall mounted. Please confirm that there is a suitable installation place before installing the filter.  
 An optional Stand Mount is available. (The mounting hole positions of Ion Exchange Resin D and E assemblies are the same as the mounting hole positions on Water Filter A and B assemblies respectively. Please refer to the Water Filter Equipment page for details regarding dimensions.)  
 ※ 5 On Ion Exchange Resin D and E assemblies, if there is a chance that the water pressure within the purification vessel will exceed 0.2MPa, a pressure reducing valve should be installed.  
 Note : Avoid installing the ion exchange resin where it will be in direct sunlight or in places where there is a risk of it being damaged.

## For Water Supply and Purification

(Keeps sudden rises in electrical conductivity down during water tank supply and replenishment.)

Model	Model Deionizer Assembly for Water Supply
Part number	04100522010
Applicable purifier	AP-10
Processing capacity ※ 1,2	L
Water quality	μS/cm
Working water pressure	MPa
Working water temperature	°C
Dimensions	φ 165 – H851mm
Unit mass	kg
Inlet connection	Universal faucet adaptor
Outlet connection	Braided hose ( φ 12 × φ 18)
Ion exchange resin part number	0A001213000
Comments	Electrical conductivity gauge (0 ~ 3 μS/cm) included Flow regulating valve (2.2 L/min) included 3 anchor bolt holes ( φ 10mm × 3)



※ 1 For water tank supply and replenishment. ※ 2 Processing capacity figure based on water source standard purity level of 200 μS/cm. Actual processing capacity may change depending on water quality, temperature, etc.  
 ※ 3 If there is a chance that the water pressure within the vessel will exceed 0.34MPa, a pressure reducing valve should be installed. Note : Avoid installation of the deionizer where it will be in direct sunlight or in places where there is a risk of it being damaged.

# Please read before adopting this equipment or making a model choice.

Please read and carefully follow the safety precautions listed herein to ensure safe and proper use of this equipment for the protection and prevention of loss to you, the surrounding area, and people nearby.



## WARNINGS

Failure to follow instructions contained in these WARNINGS may result in death or serious injury.

## Working Environment (Installation environment)



### Product Use Limitations

(1) If the unit is to be used as part of critical installations, safety devices and backup systems which can be switched to should be put into place to insure that serious accidents or losses do not occur in the event that the unit should break down or malfunction.

(2) This product was designed and produced as a general purpose device for use in ordinary manufacturing. Accordingly, the warranty does not apply to nor cover the following applications. However, in cases where the customer/user takes full responsibility and confirms the performance of the equipment in advance, and takes necessary safety precautions, please consult with ORION and we will consider if use of the unit in the desired application is appropriate.

- ① Atomic energy, aviation, aerospace, railway works, shipping, vehicles (cars and trucks), medical applications, transportation/communications applications, and/or any applications where it might have a great effect on human life or property.
- ② Electricity, gas, or water supply systems, etc. where high levels of reliability and safety are demanded.



**Please install this equipment in a place that is level, free from vibration, and one that can fully support the weight of the equipment. Always take measures to ensure the unit will not tip over.**

Not properly installing the equipment as indicated can result in water leaks, and injury from tipping over, or falling, etc.



**Never install in places where flammable gases may be present or where leakage of such flammable gases may occur.**

If by some chance such gas were to leak and collect near this equipment, a fire could break out.



**Never use this equipment in the presence of corrosive gases**

Corrosion can lead to electric shock or refrigerant leaks.

## Installation



**Please arrange for installation by your dealer or other qualified persons.**

Installation undertaken by unqualified or inexperienced persons may result in improper installation, which can lead to water leakage, electric shock, or fire.



**Be certain that all electrical wiring is done in accordance with relevant electrical construction and wiring regulations, and use only prescribed cables.**

Installation with an insufficient power supply or improper installation can result in electric shock or fire. Improperly securing cables to electrical contacts can lead to electric shock, overheating, or fire.



**When lifting this equipment via the suspension eyebolts, always use all 4 suspension eyebolts and ensure the angle of the suspension cable at the eyebolts is at least 60.**

Improper suspension may lead to the equipment tipping over or falling, which may lead to injury.



**Always install and use this equipment with an earth leakage breaker.**

Using the equipment without an earth leakage breaker can lead to electric shock.



**Ensure that the equipment is properly grounded. (Installation of a proper ground hookup must be performed by a qualified electrician.)**

Improper grounding of this equipment can lead to electric shock.

## Control and Operation



**Operation of this equipment should be carried out by persons who are knowledgeable and experienced in its operation, including related equipment, and all relevant safety guidelines.**



Failure to follow instructions contained in these CAUTIONS may result in personal injury or damage to property.

## Working Environment (Installation environment)



**Do not install this equipment in places of the following environments:**

- 1: Exposure to direct sunlight.
  - 2: Where there is a chance of freezing.
  - 3: Places with high concentrations of dirt, dust, or oil mist.
  - 4: Where the equipment might be exposed to rain water or other liquids.
  - 5: Where the ambient temperature is beyond the specified operating ambient temperature of the equipment.
  - 6: Where the surrounding humidity is outside the 25 ~ 85% range.
  - 7: In places without adequate drainage. (An exception can be made in cases where the unit can be moved to a place where it can be drained.)
- ※ If the equipment is not properly installed, burst water pipes, leaks, considerable operation degradation, or breakdown can occur.

## Installation



**Pressure of water supply should be 0.49MPa or less.**

Too high water pressure can lead to water leaks.



**Never stand on the unit. Never place anything on the unit when it is running.**



**Source power supply to the unit should be within  $\pm 10\%$  of the specified supply voltage, and phase unbalance should be less than  $\pm 3\%$ .**



**Always use piping of a material that will not rust, and install a strainer (20 ~ 40 mesh) that can filter out dirt and foreign substances.**



**Ensure that wetted surfaces that come into contact with the chilled water are not aluminum.**

Aluminum corrosion can lead to blockage within the water circuit and could lead to breakdown, so if



**Install piping such that the weight of the piping is adequately distributed and supported via brackets, and is not being supported by the equipment to which it is attached.**



**Install piping to deal with drainage from overflow and drain ports.**



**Do not run circulation or pressure pumps dry.**



**Regarding water cooled chillers, if water other than drinking water is to be used as a condenser coolant, please ensure that the cooling water used conforms to the water properties listed below.**

(Do not use pure water, treated sewage and softening-treated water.)



**Wetted parts within the water cooled condenser that come into contact with cooling water are constructed with iron piping.**

There is a chance that iron rust can occur. If this becomes a problem, please consult your dealer.

Standard Concentration Levels for Cooling Water used in Water Cooled Condensers

Item	Cooling Water Type		Has Tendency Towards:		
	Circulation water	Make-up Water	Corrosion	Scaling	
Standard Components	pH (25°C )	6.5~8.2	6.0~8.0	○	○
	Electrical conductivity ( $\mu\text{S}/\text{cm}$ )(25°C)	Max. 800	Max. 300	○	○
	Chloride ion ( $\text{mgCl}^-/\text{L}$ )	Max. 200	Max. 50	○	
	Sulphate ( $\text{mgSO}_4^{2-}/\text{L}$ )	Max. 200	Max. 50	○	
	Acid consumption(pH4.8) ( $\text{mgCaCO}_3/\text{L}$ )	Max. 100	Max. 50		○
	Total hardness ( $\text{mgCaCO}_3/\text{L}$ )	Max. 200	Max. 70		○
	Calcium hardness ( $\text{mgCaCO}_3/\text{L}$ )	Max. 150	Max. 50		○
Reference components	Silica ion ( $\text{mgSiO}_2/\text{L}$ )	Max. 50	Max. 30		○
	Iron ( $\text{mgFe}/\text{L}$ )	Max. 1.0	Max. 0.3	○	○
	Copper ( $\text{mgCu}/\text{L}$ )	Max. 0.3	Max. 0.1	○	
	Sulfide ion ( $\text{mgS}^{2-}/\text{L}$ )	Not detected	Not detected	○	
	Ammonium ion ( $\text{mgNH}_4^+/\text{L}$ )	Max. 1.0	Max. 0.1	○	
	Residual chlorine ( $\text{mgCl}/\text{L}$ )	Max. 0.3	Max. 0.3	○	
	Free carbon dioxide ( $\text{mgCO}_2/\text{L}$ )	Max. 4.0	Max. 4.0	○	
Ryznar Stability Index	6.0~7.0	—	○	○	

Excerpt from JRA-GL-02-1994 of The Japan Refrigeration and Air Conditioning Industry Association

- Within the "Tendency toward" column, items marked with a ○ indicate this component can lead to corrosion or scaling as indicated.
- The 15 items listed above are the primary components that can lead to corrosion or scaling.

**!** Plan for enough space around the unit to facilitate optimum unit performance as well as a working space for maintenance tasks.

Models without built-in water tanks:  
RKS Series (250 ~ 1500)

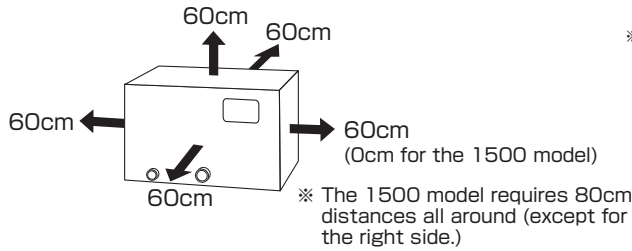

Models with built-in water tanks:  
RKS Series (400 ~ 750)

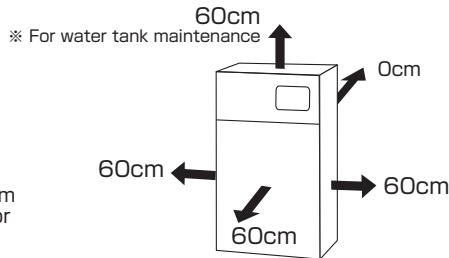

RKL, RKE, RKED Series

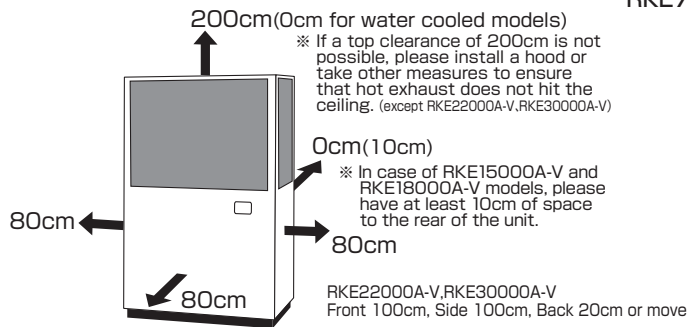

RKE750A1-V, 1500B1-V, 2200B1-V (W)

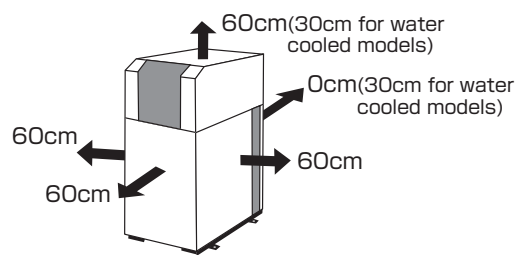

## Before Moving the Unit

**!** Please drain the water from the unit before moving.

## Standard Operation

**!** For chilled water, please use either potable water or a low concentration ethylene glycol water solution of 10% or less. If potable water cannot be used, please ensure that the water used conforms to the water properties listed below.

	Standard Components							Reference components						
	PH (25°C)	Electrical conductivity (25°C) (μS/cm)	Chloride ion (mgCl <sup>-</sup> /L)	Sulphate (mgSO <sub>4</sub> <sup>2-</sup> /L)	Acid consumption (pH4.8) (mgCaCO <sub>3</sub> /L)	Total hardness (mgCaCO <sub>3</sub> /L)	Calcium hardness (mgCaCO <sub>3</sub> /L)	Silica ion (mgSiO <sub>2</sub> /L)	Iron (mgFe/L)	Copper (mgCu/L)	Sulfide ion (mgS <sup>2-</sup> /L)	Ammonium ion (mgNH <sub>4</sub> <sup>+</sup> /L)	Residual chlorine (mgCl/L)	Free carbon dioxide (mgCO <sub>2</sub> /L)
Standard level	6.8 ~8.0	1~400	Max. 50	Max. 50	Max. 50	Max. 70	Max. 50	Max. 30	Max 1.0	Max 1.0	Not detected	Max 1.0	Max 0.3	Max 4.0

\* From JRA GL-02-1994 (water circulation for water cooled systems)

If the quality of water to be used for cooling does not fall within the prescribed guidelines, it may result in corrosion in the circulation or heat exchanger of the equipment, clogging, etc. Please confirm water quality prior to use.

Also, if the chilled water is dirty, corrosion may occur even if the concentration of chloride ion is below 10mgCl<sup>-</sup>/L, so please replace water regularly.

**!** Please consult your dealer before using any water additives. Troubles such as the water becoming dirty, or damage to the heat exchanger from clogging etc. can result depending on the type of additive used.

**!** Always apply power to the unit at least 12 hours before conducting initial test runs, or when the unit has been unpowered for over 24 hours.

(Unit Cooler RKL and RKE Series)

Failure to apply power in advance as directed can lead to damage to the refrigeration compressor.

## Maintenance Inspection

**!** Please ensure all safety requirements have been met regarding the main unit as well as all related equipment.

- Every month check that the water is clean, and free of slime, dirt, strange odor, and foreign substances, and perform cleaning at regular fixed intervals.
- Every month inspect the condenser and condenser filter for dirt and perform cleaning at regular fixed intervals.
- For models that have a built-in inverter, clean the inverter cooling fan and fins every 6 months. In addition, the inverter circuitry holds a charge, so do not remove the inverter cover. Doing so may lead to an electric shock.
- Every 6 months, check the water is not leaking from the discharge pump. In case of water leaks, mechanical seals should be replaced.



# For stable and reassured chiller operation, ORION Fixed Term Chiller Inspection is Recommended.

Computer based performance specifications  
diagnosis for reliable troubleshooting!

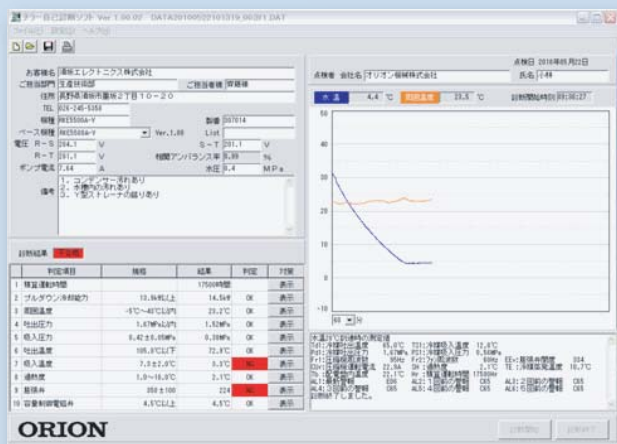

(Image computer transmitted data display)

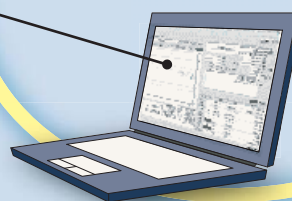

## Merits of Fixed Term Inspections

- Sharp cuts in running costs!
- Maintain stable performance specifications via PC based chiller diagnosis!
- Clear display of contact numbers in case of trouble!

## Failure to perform inspections and service leads to:

- Drop in cooling capacity.
- Higher risk of increased power consumption and higher risk of line stops as a result.

## ORION Chiller Diagnosis and Inspection Procedure

※Please ask about diagnosis inspection compatibilities of the model in question.  
※In addition to diagnosis inspection, other general inspection options are available.



**Preventive maintenance provides peace of mind.**

**Peace of mind from knowing your chillers are running stable.**

**Peace of mind from having a clear record of maintenance management.**

# Feeling the limits of machining precision?

## Features

### 1. Fluid temperature control accuracy: $\pm 0.5^{\circ}\text{C}$ \*

Uses DC inverter compressor.  
High accuracy, energy saving operation.  
\*At the time of a cooling load and ambient temperature stability  
(In the case of setting liquid temperature 15-30 degrees celsius)

### 2. Easy installation

Operation possible by just putting a hose into the coolant tank.  
Even easier installation possible with our optional piping.



I only have access to the plumbing in a tank in operation

### 3. Easy disassembly and cleaning of the cooling unit. Patent pending

Dirt and purity of the cooling unit is normally a constant concern.  
In response, ORION has designed its Coolant Chiller for easy disassembly and cleaning!



## Chiller systems until now:

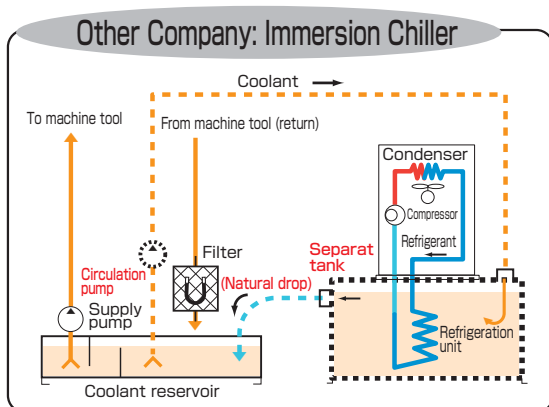

■ A shallow tank means extra equipment needed:

- ① Separate tank
- ② Separate tank
- ③ Natural drop piping

■ High total cost of additional equipment

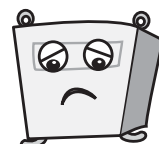

RCC1500B1

RCC750B1



From now on simple installation and maintenance is better.

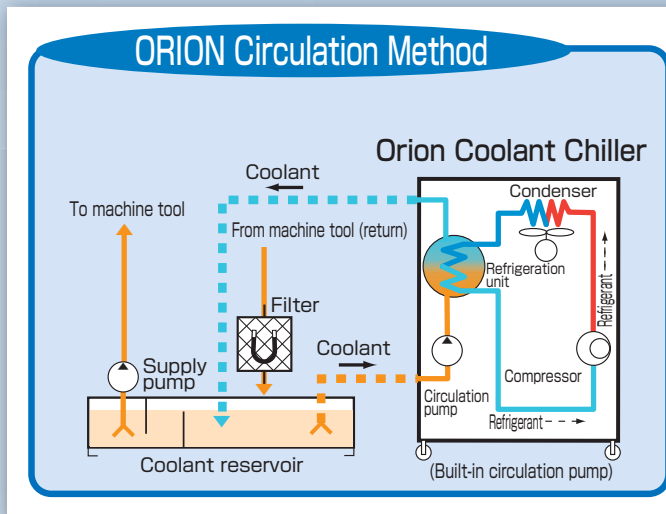

- Easy installation to the existing tank.
- Easy to clean evaporator.
- Hose piping for easy installation. Our optional piping equipment, makes installation and maintenance easy and speedy.



### Specifications

Item / Model	RCC750B1	RCC1500B1	RCC750B1-H(w/heater)	RCC1500B1-H(w/heater)
Performance specifications				
Cooling capacity ※1	2.5kW	4.65kW	2.5kW	4.65kW
Ambient temp. range	10~40°C			
Fluid temp. range	15~40°C (Constant temperature control · Bifference temperature control)			
Electric heater for warming hydraulic fluid temperature range	-		25°C or less	
Water temperature control accuracy ※1※2	± 0.5°C of the set temperature		Setting temperature ±0.5°C or less	
Power source	3-phase 200V@50/60Hz, 220V@60Hz		Three phase 200V50/60Hz	
Power consumption ※1	1.3kW	2.1kW	1.5kW ※3	2.4kW ※3
Temperature control method	Digital electronic temperature control system			
Electric heater for warming	-		1.2kW	2.1kW
Mass	70kg	85kg	74kg	89kg

※1 Fluid temp.: 20°C, room temp.: 32°C, 200V, 60Hz ※2 When cooling load and ambient temperature are stable. But the next case is excluded. ①It is less than four minutes after the start of the compressor. ②At the time of compressor ON-OFF control driving by the low load cooling driving. ③In the case of setting temperature 31 degrees Celsius-40 degrees Celsius ※3 At the time of warming heater electricity.

● Please contact us regarding possible compatible coolant fluids.

● Differential temperature control also possible. Note: Differential temperature sensor is optional.

**Filter**

**Before using:** Please clean the coolant with a drum filter, magnetic separator, cyclone filter, paper filter, or other filtration method before use.

**Effect** Filtering effectively improves production surfaces, prevents dirt in the tank and on the cooling coil, and prevents degradation of cooling capacity.

### External dimensions

RCC750B1  
RCC750B1-H

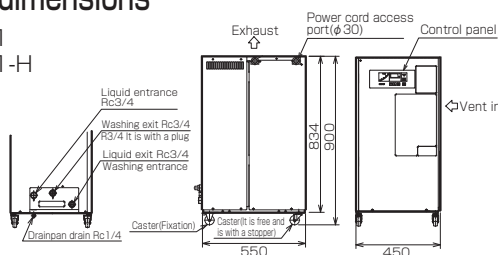

RCC1500B1  
RCC1500B1-H

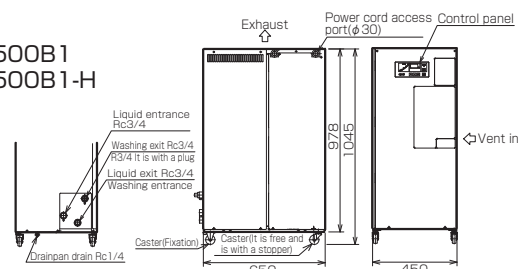



## Orion Products -- Service and Safety

### ● Safety Notes

- Before using this equipment, read the operating manual thoroughly and operate the equipment correctly as directed.
- Consult with a qualified professional or your ORION dealer for product installation and wiring.
- Please select a product that is suitable for the desired application. Do not use for other than intended purposes. Use for other than intended purposes can lead to accidents or unit breakdown.

### ● Air-Cooled Spec. Models

If the condenser becomes clogged with dust or dirt, heat exchange will be greatly reduced and electricity consumption will increase. This will lead not only to decreased performance, but can also lead to the activation of built-in safety devices, and eventual damage to the equipment. For these reasons, the condenser should be cleaned on a regular basis.

### ● Water-Cooled Spec. Models

In general, water used to cool condensers will be well water, tap water, or water from a cooling tower. However water of insufficient quality can lead to scaling in cooling pipes resulting in lower levels of heat exchange, increased electricity consumption and lower performance. Therefore water quality should be confirmed on a regular basis.

### ● Recirculating Chilled Water

For chilled water, please use either potable water or a low concentration ethylene glycol water solution of 10% or less. In case of use of deionized water, keep the electric conductivity at 1 microsiemens/cm or above. If the quality of chilled water does not fall within the guidelines, it may result in damage of the mechanical seals, water leaks, electric leak/shock, etc.

### Regarding After Service

- Please contact your dealer for any repairs required after using this unit.
- Costs will be incurred by the customer for repairs conducted after the warranty period has expired. In cases where equipment function can be improved by certain service procedures, such procedures will be taken at the specific request of the customer. Spare parts are items necessary to maintain the proper function and operating specifications of the equipment. It is the policy of ORION to maintain a stock of replacement parts for 7 years after production of the product ceases.

### Recommended Maintenance Inspections

- After having used the unit for a long time, actual performance may drop due to the effects of dirt or wear, etc. In order to realize continued best performance of this equipment, in addition to prescribed customer maintenance, it is also recommended that regular inspections be conducted. (Service and inspection fees apply.) For further information please consult with your dealer or contact ORION directly.

ORION is continuing to develop a complete and trustworthy nationwide network of expedient sales and service -- everywhere, anytime.

ORION Machinery Co., Ltd.



ORION Machinery Co., Ltd is an ISO Certified, Quality Management and Environmental Management company.

#### What is the ISO certification system?

ISO (International Organization for Standardization) is an established body that stipulates and certifies ISO9001 and ISO14001 directives. ISO9001 stipulates a system of Quality Management that ensures customer satisfaction and trust in a company's products and services it provides. ISO14001 stipulates a system of Environmental Management whereby production and business activities are carried out in an environmentally conscious manner.

## For Orders and Inquiries:



**ORION MACHINERY CO., LTD.**

International Group 246, Kotaka, Suzaka-shi, Nagano-ken, 382-8502 Japan  
TEL +81-(0)26-246-5664 FAX +81-(0)26-246-6753  
Email: kokusai@orionkikai.co.jp

Head Office & Factory 246, Kotaka, Suzaka-shi, Nagano-ken, 382-8502 Japan  
TEL +81-(0)26-245-1230 FAX +81-(0)26-245-5424  
URL: <http://www.orionkikai.co.jp>

This catalogue contains product specifications as of Dec, 2012.

- Actual product colors may vary slightly from catalogue.
- The structure or specifications of products contained in this catalogue are subject to change without prior notice.